

## Sertifika

Bu belge ile

### ASTAŞ MAĞAZA EKİPMANLARI İMALAT SANAYİ VE TİCARET LTD. ŞTİ.

Aksaray Konya Karayolu 12. Km 68200 Aksaray, Turkey

firmanın aşağıda belirtilen Kalite Sistemi standart şartlarını sağlamış olduğu kanıtlanmıştır

ISO 9001:2008

Firmanın faaliyet alanı aşağıda belirtilmiştir

### MARKET RAFLARI, MAĞAZA RAFLARI VE DEPO RAF SİSTEMLERİ ÜRETİMİ VE SATIŞI

Sertifika Numarası: 33855/A/0001/UK/Tr  
Basılma Tarihi: (Orijinal) 12 Şubat 2009  
Basılma Tarihi: 22 Şubat 2012  
Baskı No: 2  
Bitiş Tarihi: 21 Şubat 2015

Belgeyi Veren: *Jaul* Sertifika yöneticisi adına



If there is any doubt as to the authenticity of this certificate, please do not hesitate to contact the Chief of the Group and/or the Group Audit and Compliance Department.

Cert.111 İss 0408

TSEK

## TÜRK STANDARLARI ENSTİTÜSÜ KRİTERE UYGUNLUK BELGESİ TURKISH STANDARDS INSTITUTION CERTIFICATE OF CONFORMANCE TO CRITERIA

Markanın Tanımı Description of the Mark

TSEK veya / or TSEK

BELGE NUMARASI REFERENCE NUMBER OF LICENCE	: 14.11.42/TSEK-498
BELGENİN İLK VERİŞ TARİHİ DATE OF FIRST ISSUE OF LICENCE	: 01/12/2005
BELGENİN SON GEÇERLİLİK TARİHİ LICENCE VALID UNTIL	: 01/12/2011
BELGE SAHİBİ KURULUŞUN ADI NAME OF THE LICENCE HOLDER	: ASTAŞ MAĞAZA EKİPMANLARI İMALAT SANAYİ VE TİCARET LTD.ŞTİ.
BELGE SAHİBİ KURULUŞUN ADRESİ ADDRESS OF THE LICENCE HOLDER	: AKSARAY-KONYA YOLU 12.KM. YAPILCAN MEVKİLİ - AKSARAY / TÜRKİYE
ÜRETİM YERİ ADI NAME OF THE MANUFACTURING PLACE	: ASTAŞ MAĞAZA EKİPMANLARI İMALAT SANAYİ VE TİCARET LTD.ŞTİ.
ÜRETİM YERİ ADRESİ ADDRESS OF THE MANUFACTURING PLACE	: AKSARAY-KONYA YOLU 12.KM.YAPILCAN MEVKİLİ AKSARAY/TÜRKİYE
TESCİLLİ TİCARİ MARKASI REGISTERED TRADE MARK	: "ASTAŞ" MARKALI
İLGİLİ BELGELENDİRME KRİTERİ RELATED CERTIFICATE CRITERIA	: UBM-00-BK-000/20.4.1972
BELGE KAPSAMI SCOPE OF LICENCE	: MAĞAZA EKİPMANLARI -DUVAR REYONLARI.



24/12/2010

Ayşin YILMAZ  
Konya Ürün Belgeleendirme Müdürü

\*Enstitümüzce verilmekte olan "İmalata Yeterlilik Belgesi" 15.04.2007 tarihinden itibaren uygulanmadan kaldırılmıştır.

\*Bu belge, belgelendirilen ürünün, üretim yerinin Enstitümüzün belirlediği şartları karşıladığını da gösterir.

\*Bu belge ile hak kazanılan TSEK Markası, ürünün TSE tarafından belirlenen kriterlere uygunluğunu ve bu uygunluğun belgelendirildiğini ifade eder.

KONYA KONYA KONYA ORGANİZE SANAYİ BÖLGESİ VEZİRKÖY CAD. KOCADERE SOKAK NO:9 tel: 0332 239 04 80 faks: 0332 239 04 83

Bu belge hiçbir şekilde satılmamalıdır, kopya veya okunmasını zorlaştıracak şekilde çoğaltılmamalı, kâğıdı ve simsiyah yapılmamalıdır.



T.C.  
TÜRK PATENT ENSTİTÜSÜ

## MARKA YENİLEME BELGESİ

Marka No : 2000 25567 - Ticaret



Marka Sahibi : ASTAŞ MAĞAZA EKİPMANLARI İMALAT SANAYİ VE  
TİCARET LİMİTED ŞİRKETİ  
TÜRKİYE CUMHURİYETİ  
Yeni Sanayi Sitesi 24.Blok No:16 AKSARAY

Emtiası : 06  
Metalden alet kutuları, malzeme kutuları, posta kutuları, madeni  
tezgahlar, raflar, madeni bankolar, market rafları ve reyonları...

İş bu Marka ilk defa 24/11/2000 tarihinde tescil edilmiş olup, 556 Sayılı Markaların Korunması Hakkında Kanun Hükmünde Kararnamenin 40. Maddesi gereğince 24/11/2010 tarihinden itibaren ON YIL süreyle yenilenmiştir.

KURBANBAS  
Enstitü Başkanı a.  
Markalar Dairesi Başkanı

TÜRK PATENT [ ] ENSTİTÜSÜ



T.C.  
TÜRK PATENT ENSTİTÜSÜ

## TASARIM TESCİL BELGESİ

TESCİL NUMARASI : 2011 00298



Bu belge ekinde yer alan tasarım, 19/01/2011 tarihinde tescil edilmiş olup 554 Sayılı Endüstriyel Tasarımların Korunması Hakkında Kanun Hükmünde Kararname'nin 12 nci maddesi gereğince 5 yıl süre ile korunmaktadır. İşbu belge 29/09/2011 tarihinde düzenlenmiştir

Naim UĞUR  
Enstitü Başkanı a.  
Endüstriyel Tasarımlar Dairesi Başkanı



TÜRK PATENT [ ] ENSTİTÜSÜ

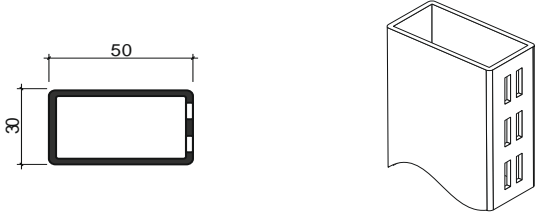

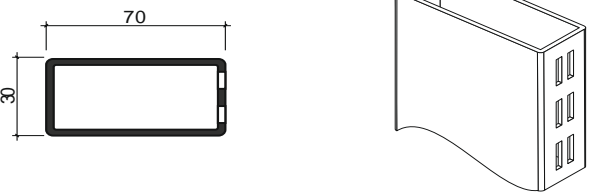
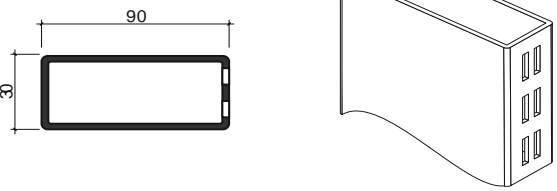
Ürün Adı ve Görseli / Product Name And The Image	Ölçü / Size HxLxP	Kod no / Code no	Br	Birim Fiyat / Unit Price
Profil Tek Yönlü / Upright One Side Slotted 	H 1100 H 1390 H 1680 H 1970 H 2250 H 2550 H 2830	P 11 1100 0030 0050 2,0 P 11 1390 0030 0050 2,0 P 11 1680 0030 0050 2,0 P 11 1970 0030 0050 2,0 P 11 2250 0030 0050 2,0 P 11 2550 0030 0050 2,0 P 11 2830 0030 0050 2,0	Ad Ad Ad Ad Ad Ad Ad	
Profil Tek Yönlü / Upright One Side Slotted 	H 1100 H 1390 H 1680 H 1970 H 2250 H 2550 H 2830  H 1100 H 1390 H 1680 H 1970 H 2250 H 2550 H 2830	P 11 1100 0030 0060 2,0 P 11 1390 0030 0060 2,0 P 11 1680 0030 0060 2,0 P 11 1970 0030 0060 2,0 P 11 2250 0030 0060 2,0 P 11 2550 0030 0060 2,0 P 11 2830 0030 0060 2,0  P 11 1100 0030 0060 2,5 P 11 1390 0030 0060 2,5 P 11 1680 0030 0060 2,5 P 11 1970 0030 0060 2,5 P 11 2250 0030 0060 2,5 P 11 2550 0030 0060 2,5 P 11 2830 0030 0060 2,5	Ad Ad Ad Ad Ad Ad Ad  Ad Ad Ad Ad Ad Ad	
Profil Tek Yönlü / Upright One Side Slotted 	H 1100 H 1390 H 1680 H 1970 H 2250 H 2550 H 2830	P 11 1100 0030 0070 2,5 P 11 1390 0030 0070 2,5 P 11 1680 0030 0070 2,5 P 11 1970 0030 0070 2,5 P 11 2250 0030 0070 2,5 P 11 2550 0030 0070 2,5 P 11 2830 0030 0070 2,5	Ad Ad Ad Ad Ad Ad Ad	
Profil Tek Yönlü / Upright One Side Slotted 	H 1100 H 1390 H 1680 H 1970 H 2250 H 2550 H 2830  H 1100 H 1390 H 1680 H 1970 H 2250 H 2550 H 2830	P 11 1100 0030 0090 2,5 P 11 1390 0030 0090 2,5 P 11 1680 0030 0090 2,5 P 11 1970 0030 0090 2,5 P 11 2250 0030 0090 2,5 P 11 2550 0030 0090 2,5 P 11 2830 0030 0090 2,5  P 11 1100 0030 0060 3,0 P 11 1390 0030 0060 3,0 P 11 1680 0030 0060 3,0 P 11 1970 0030 0060 3,0 P 11 2250 0030 0060 3,0 P 11 2550 0030 0060 3,0 P 11 2830 0030 0060 3,0	Ad Ad Ad Ad Ad Ad Ad  Ad Ad Ad Ad Ad Ad	

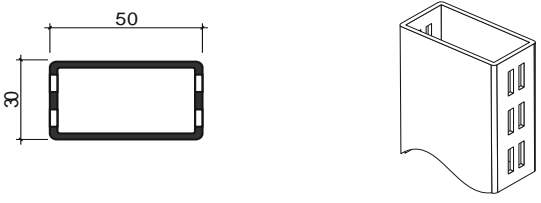
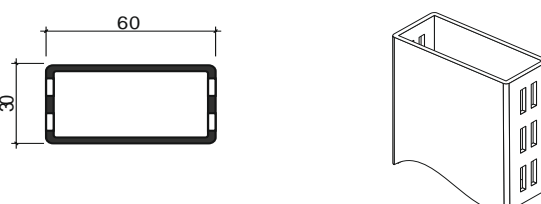
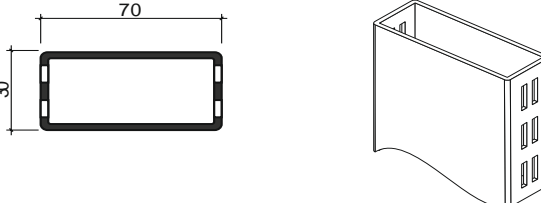
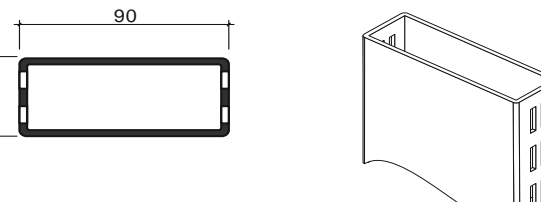

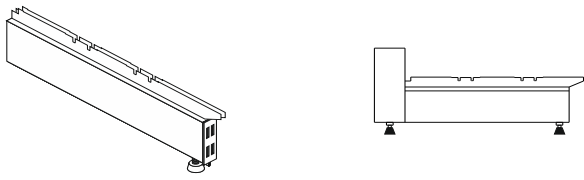
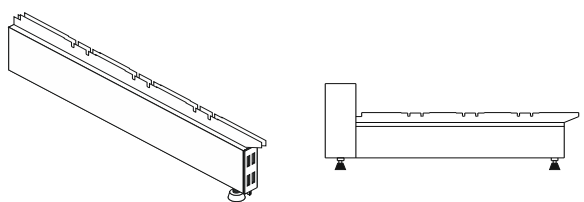
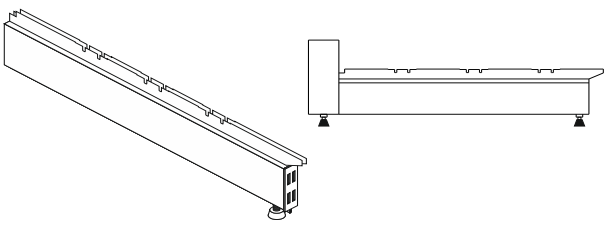
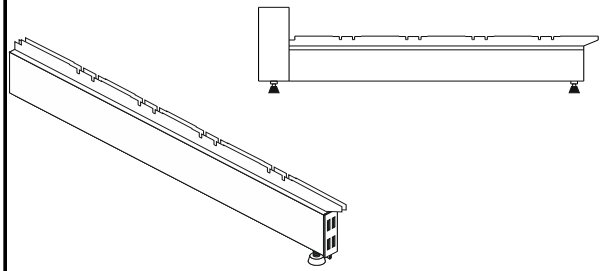

Ürün Adı ve Görseli / Product Name And The Image	Ölçü / Size HxLxP	Kod no / Code no	Br	Birim Fiyat / Unit Price
Profil Çift Yönlü / Upright Two Side Slotted 	H 1100	P 12 1100 0030 0050 2,0	Ad	
	H 1390	P 12 1390 0030 0050 2,0	Ad	
	H 1680	P 12 1680 0030 0050 2,0	Ad	
	H 1970	P 12 1970 0030 0050 2,0	Ad	
	H 2250	P 12 2250 0030 0050 2,0	Ad	
	H 2550	P 12 2550 0030 0050 2,0	Ad	
	H 2830	P 12 2830 0030 0050 2,0	Ad	
	Profil Çift Yönlü / Upright Two Side Slotted 	H 1100	P 12 1100 0030 0060 2,0	Ad
H 1390		P 12 1390 0030 0060 2,0	Ad	
H 1680		P 12 1680 0030 0060 2,0	Ad	
H 1970		P 12 1970 0030 0060 2,0	Ad	
H 2250		P 12 2250 0030 0060 2,0	Ad	
H 2550		P 12 2550 0030 0060 2,0	Ad	
H 2830		P 12 2830 0030 0060 2,0	Ad	
H 1100		P 12 1100 0030 0060 2,5	Ad	
H 1390		P 12 1390 0030 0060 2,5	Ad	
H 1680		P 12 1680 0030 0060 2,5	Ad	
H 1970		P 12 1970 0030 0060 2,5	Ad	
H 2250		P 12 2250 0030 0060 2,5	Ad	
H 2550		P 12 2550 0030 0060 2,5	Ad	
H 2830		P 12 2830 0030 0060 2,5	Ad	
Profil Çift Yönlü / Upright Two Side Slotted 	H 1100	P 12 1100 0030 0070 2,5	Ad	
	H 1390	P 12 1390 0030 0070 2,5	Ad	
	H 1680	P 12 1680 0030 0070 2,5	Ad	
	H 1970	P 12 1970 0030 0070 2,5	Ad	
	H 2250	P 12 2250 0030 0070 2,5	Ad	
	H 2550	P 12 2550 0030 0070 2,5	Ad	
	H 2830	P 12 2830 0030 0070 2,5	Ad	
	Profil Çift Yönlü / Upright Two Side Slotted 	H 1100	P 12 1100 0030 0090 2,5	Ad
H 1390		P 12 1390 0030 0090 2,5	Ad	
H 1680		P 12 1680 0030 0090 2,5	Ad	
H 1970		P 12 1970 0030 0090 2,5	Ad	
H 2250		P 12 2250 0030 0090 2,5	Ad	
H 2550		P 12 2550 0030 0090 2,5	Ad	
H 2830		P 12 2830 0030 0090 2,5	Ad	
H 1100		P 12 1100 0030 0060 3,0	Ad	
H 1390		P 12 1390 0030 0060 3,0	Ad	
H 1680		P 12 1680 0030 0060 3,0	Ad	
H 1970		P 12 1970 0030 0060 3,0	Ad	
H 2250		P 12 2250 0030 0060 3,0	Ad	
H 2550		P 12 2550 0030 0060 3,0	Ad	
H 2830		P 12 2830 0030 0060 3,0	Ad	

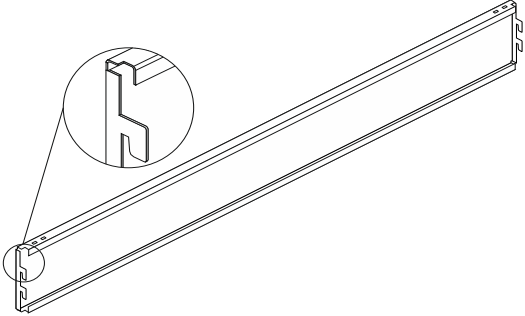
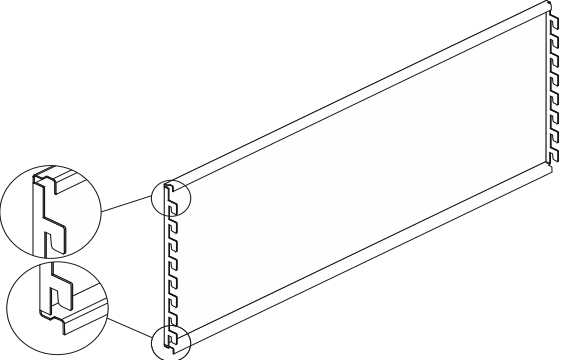

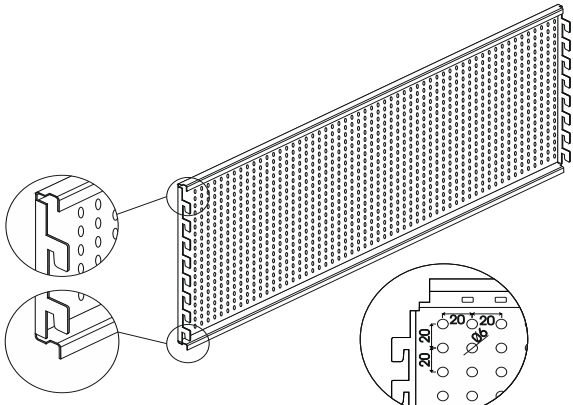
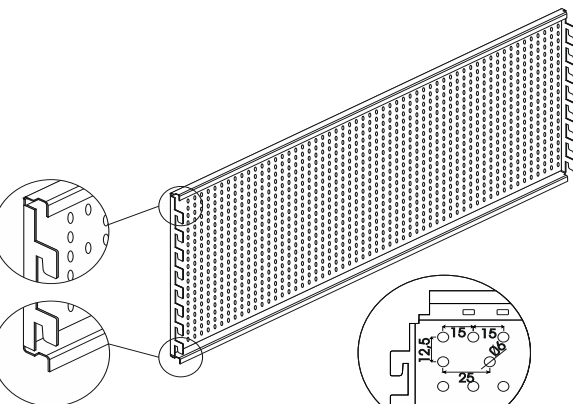

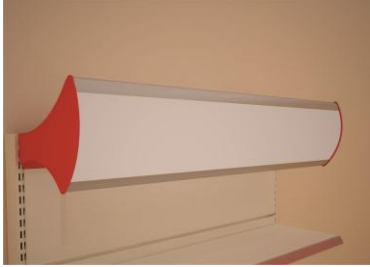

Ürün Adı ve Görseli / Product Name And The Image	Ölçü / Size HxLxP	Kod no / Code no	Br	Birim Fiyat / Unit Price
Geçme Ayak / Base Foot 	P 300	P 19 0130 0030 0300 1,5	Ad	
	P 300	P 19 0130 0030 0300 2,0	Ad	
	P 300	P 19 0130 0030 0300 2,5	Ad	
Geçme Ayak / Base Foot 	P 400	P 19 0130 0030 0400 1,5	Ad	
	P 400	P 19 0130 0030 0400 2,0	Ad	
	P 400	P 19 0130 0030 0400 2,5	Ad	
Geçme Ayak / Base Foot 	P 500	P 19 0130 0030 0500 1,5	Ad	
	P 500	P 19 0130 0030 0500 2,0	Ad	
	P 500	P 19 0130 0030 0500 2,5	Ad	
Geçme Ayak / Base Foot 	P 600	P 19 0130 0030 0600 1,5	Ad	
	P 600	P 19 0130 0030 0600 2,0	Ad	
	P 600	P 19 0130 0030 0600 2,5	Ad	
Geçme Ayak / Base Foot 	P 700	P 19 0130 0030 0700 1,5	Ad	
	P 700	P 19 0130 0030 0700 2,0	Ad	
	P 700	P 19 0130 0030 0700 2,5	Ad	

Ürün Adı ve Görseli / Product Name And The Image	Ölçü / Size HxLxP	Kod no / Code no	Br	Birim Fiyat Unit Price	
Arka Pano / Back Panel 	H 100 L 600	P 21 0100 0600 0020	0,6	Ad	
	H 100 L 700	P 21 0100 0700 0020	0,6	Ad	
	H 100 L 800	P 21 0100 0800 0020	0,6	Ad	
	H 100 L 900	P 21 0100 0900 0020	0,6	Ad	
	H 100 L 1000	P 21 0100 1000 0020	0,6	Ad	
	H 100 L 1150	P 21 0100 1150 0020	0,6	Ad	
	H 100 L 1250	P 21 0100 1250 0020	0,6	Ad	
	H 100 L 1330	P 21 0100 1330 0020	0,6	Ad	
	H 100 L 600	P 21 0100 0600 0020	0,7	Ad	
	H 100 L 700	P 21 0100 0700 0020	0,7	Ad	
	H 100 L 800	P 21 0100 0800 0020	0,7	Ad	
	H 100 L 900	P 21 0100 0900 0020	0,7	Ad	
	H 100 L 1000	P 21 0100 1000 0020	0,7	Ad	
	H 100 L 1150	P 21 0100 1150 0020	0,7	Ad	
	H 100 L 1250	P 21 0100 1250 0020	0,7	Ad	
	H 100 L 1330	P 21 0100 1330 0020	0,7	Ad	
	Arka Pano / Back Panel 	H 290 L 600	P 21 0290 0600 0020	0,6	Ad
		H 290 L 700	P 21 0290 0700 0020	0,6	Ad
		H 290 L 800	P 21 0290 0800 0020	0,6	Ad
		H 290 L 900	P 21 0290 0900 0020	0,6	Ad
H 290 L 1000		P 21 0290 1000 0020	0,6	Ad	
H 290 L 1150		P 21 0290 1150 0020	0,6	Ad	
H 290 L 1250		P 21 0290 1250 0020	0,6	Ad	
H 290 L 1330		P 21 0290 1330 0020	0,6	Ad	
H 290 L 600		P 21 0290 0600 0020	0,7	Ad	
H 290 L 700		P 21 0290 0700 0020	0,7	Ad	
H 290 L 800		P 21 0290 0800 0020	0,7	Ad	
H 290 L 900		P 21 0290 0900 0020	0,7	Ad	
H 290 L 1000		P 21 0290 1000 0020	0,7	Ad	
H 290 L 1150		P 21 0290 1150 0020	0,7	Ad	
H 290 L 1250		P 21 0290 1250 0020	0,7	Ad	
H 290 L 1330		P 21 0290 1330 0020	0,7	Ad	
H 290 L 600		P 21 0290 0600 0020	0,8	Ad	
H 290 L 700		P 21 0290 0700 0020	0,8	Ad	
H 290 L 800		P 21 0290 0800 0020	0,8	Ad	
H 290 L 900		P 21 0290 0900 0020	0,8	Ad	
H 290 L 1000	P 21 0290 1000 0020	0,8	Ad		
H 290 L 1150	P 21 0290 1150 0020	0,8	Ad		
H 290 L 1250	P 21 0290 1250 0020	0,8	Ad		
H 290 L 1330	P 21 0290 1330 0020	0,8	Ad		



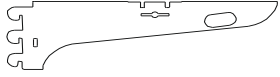

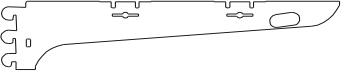
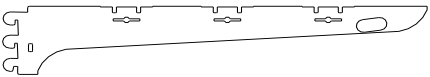
Ürün Adı ve Görseli / Product Name And The Image	Ölçü / Size HxLxP	Kod no / Code no	Br	Birim Fiyat Unit Price	
<b>Delikli Arka Pano / Perforated Back Panel</b> 	H 290 L 600	P 22 0290 0600 0020	0,8	Ad	
	H 290 L 700	P 22 0290 0700 0020	0,8	Ad	
	H 290 L 800	P 22 0290 0800 0020	0,8	Ad	
	H 290 L 900	P 22 0290 0900 0020	0,8	Ad	
	H 290 L 1000	P 22 0290 1000 0020	0,8	Ad	
	H 290 L 1150	P 22 0290 1150 0020	0,8	Ad	
	H 290 L 1250	P 22 0290 1250 0020	0,8	Ad	
	H 290 L 1330	P 22 0290 1330 0020	0,8	Ad	
	H 290 L 600	P 22 0290 0600 0020	1,0	Ad	
	H 290 L 700	P 22 0290 0700 0020	1,0	Ad	
	H 290 L 800	P 22 0290 0800 0020	1,0	Ad	
	H 290 L 900	P 22 0290 0900 0020	1,0	Ad	
	H 290 L 1000	P 22 0290 1000 0020	1,0	Ad	
	H 290 L 1150	P 22 0290 1150 0020	1,0	Ad	
	H 290 L 1250	P 22 0290 1250 0020	1,0	Ad	
	H 290 L 1330	P 22 0290 1330 0020	1,0	Ad	
	H 290 L 600	P 22 0290 0600 0020	1,2	Ad	
	H 290 L 700	P 22 0290 0700 0020	1,2	Ad	
	H 290 L 800	P 22 0290 0800 0020	1,2	Ad	
	H 290 L 900	P 22 0290 0900 0020	1,2	Ad	
	H 290 L 1000	P 22 0290 1000 0020	1,2	Ad	
	H 290 L 1150	P 22 0290 1150 0020	1,2	Ad	
	H 290 L 1250	P 22 0290 1250 0020	1,2	Ad	
	H 290 L 1330	P 22 0290 1330 0020	1,2	Ad	
	<b>Delikli Arka Pano Euro / Perforated Back Panel Euro</b> 	H 290 L 600	P 23 0290 0600 0020	0,8	Ad
		H 290 L 700	P 23 0290 0700 0020	0,8	Ad
		H 290 L 800	P 23 0290 0800 0020	0,8	Ad
		H 290 L 900	P 23 0290 0900 0020	0,8	Ad
		H 290 L 1000	P 23 0290 1000 0020	0,8	Ad
		H 290 L 1150	P 23 0290 1150 0020	0,8	Ad
		H 290 L 1250	P 23 0290 1250 0020	0,8	Ad
		H 290 L 1330	P 23 0290 1330 0020	0,8	Ad
		H 290 L 600	P 23 0290 0600 0020	1,0	Ad
		H 290 L 700	P 23 0290 0700 0020	1,0	Ad
		H 290 L 800	P 23 0290 0800 0020	1,0	Ad
		H 290 L 900	P 23 0290 0900 0020	1,0	Ad
H 290 L 1000		P 23 0290 1000 0020	1,0	Ad	
H 290 L 1150		P 23 0290 1150 0020	1,0	Ad	
H 290 L 1250		P 23 0290 1250 0020	1,0	Ad	
H 290 L 1330		P 23 0290 1330 0020	1,0	Ad	
H 290 L 600		P 23 0290 0600 0020	1,2	Ad	
H 290 L 700		P 23 0290 0700 0020	1,2	Ad	
H 290 L 800		P 23 0290 0800 0020	1,2	Ad	
H 290 L 900		P 23 0290 0900 0020	1,2	Ad	
H 290 L 1000		P 23 0290 1000 0020	1,2	Ad	
H 290 L 1150		P 23 0290 1150 0020	1,2	Ad	
H 290 L 1250		P 23 0290 1250 0020	1,2	Ad	
H 290 L 1330		P 23 0290 1330 0020	1,2	Ad	



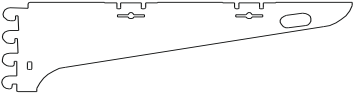
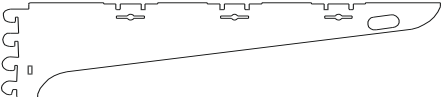
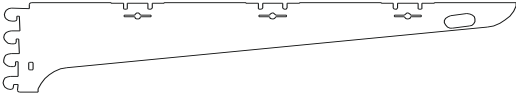
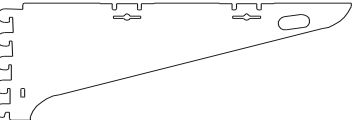
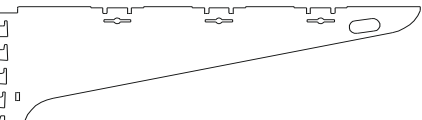
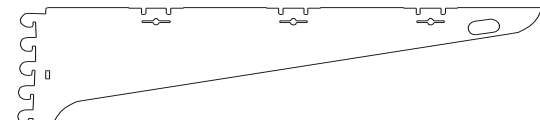
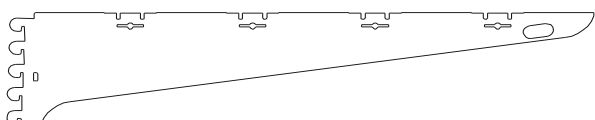

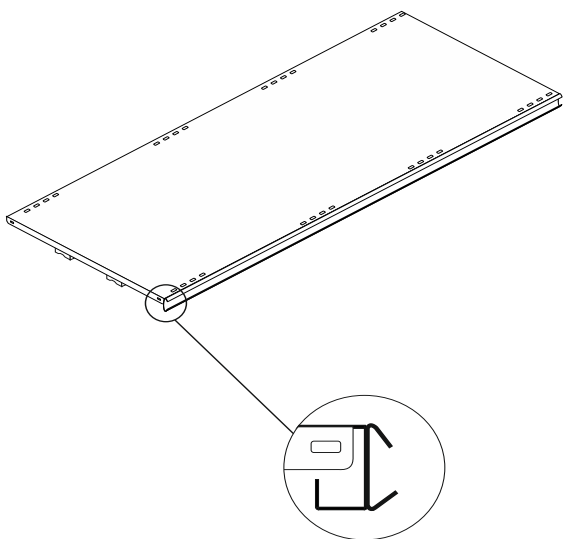
Ürün Adı ve Görseli / Product Name And The Image	Ölçü / Size HxLxP	Kod no / Code no	Br	Birim Fiyat / Unit Price
Üst Pano / Top Panel 	H 200 L 600	P 31 0200 0600 0500 1,0	Ad	
	H 200 L 700	P 31 0200 0700 0500 1,0	Ad	
	H 200 L 200	P 31 0200 0800 0500 1,0	Ad	
	H 200 L 900	P 31 0200 0900 0500 1,0	Ad	
	H 200 L 1000	P 31 0200 1000 0500 1,0	Ad	
	H 200 L 1150	P 31 0200 1150 0500 1,0	Ad	
	H 200 L 1250	P 31 0200 1250 0500 1,0	Ad	
	H 200 L 1330	P 31 0200 1330 0500 1,0	Ad	
Üst Pano / Top Panel 	H 270 L 600	P 31 0270 0600 0330 2,5	Ad	
	H 270 L 700	P 31 0270 0700 0330 2,5	Ad	
	H 270 L 800	P 31 0270 0800 0330 2,5	Ad	
	H 270 L 900	P 31 0270 0900 0330 2,5	Ad	
	H 270 L 1000	P 31 0270 1000 0330 2,5	Ad	
	H 270 L 1150	P 31 0270 1150 0330 2,5	Ad	
	H 270 L 1250	P 31 0270 1250 0330 2,5	Ad	
	H 270 L 1330	P 31 0270 1330 0330 2,5	Ad	
Üst Pano / Top Panel 	H 400 L 600	P 31 0400 0600 0900 2,5	Ad	
	H 400 L 700	P 31 0400 0700 0900 2,5	Ad	
	H 400 L 800	P 31 0400 0800 0900 2,5	Ad	
	H 400 L 900	P 31 0400 0900 0900 2,5	Ad	
	H 400 L 1000	P 31 0400 1000 0900 2,5	Ad	
	H 400 L 1150	P 31 0400 1150 0900 2,5	Ad	
	H 400 L 1250	P 31 0400 1250 0900 2,5	Ad	
	H 400 L 1330	P 31 0400 1330 0900 2,5	Ad	
Üst Pano / Top Panel 	H 500 L 600	P 31 0500 0600 0200 1,0	Ad	
	H 500 L 700	P 31 0500 0700 0200 1,0	Ad	
	H 500 L 800	P 31 0500 0800 0200 1,0	Ad	
	H 500 L 900	P 31 0500 0900 0200 1,0	Ad	
	H 500 L 1000	P 31 0500 1000 0200 1,0	Ad	
	H 500 L 1150	P 31 0500 1150 0200 1,0	Ad	
	H 500 L 1250	P 31 0500 1250 0200 1,0	Ad	
	H 500 L 1330	P 31 0500 1330 0200 1,0	Ad	
Üst Pano / Top Panel 	H 500 L 600	P 31 0500 0600 0700 2,5	Ad	
	H 500 L 700	P 31 0500 0700 0700 2,5	Ad	
	H 500 L 800	P 31 0500 0800 0700 2,5	Ad	
	H 500 L 900	P 31 0500 0900 0700 2,5	Ad	
	H 500 L 1000	P 31 0500 1000 0700 2,5	Ad	
	H 500 L 1150	P 31 0500 1150 0700 2,5	Ad	
	H 500 L 1250	P 31 0500 1250 0700 2,5	Ad	
	H 500 L 1330	P 31 0500 1330 0700 2,5	Ad	
Üst Pano / Top Panel 	H 800 L 600	P 31 0800 0600 0200 1,0	Ad	
	H 800 L 700	P 31 0800 0700 0200 1,0	Ad	
	H 800 L 800	P 31 0800 0800 0200 1,0	Ad	
	H 800 L 900	P 31 0800 0900 0200 1,0	Ad	
	H 800 L 1000	P 31 0800 1000 0200 1,0	Ad	
	H 800 L 1150	P 31 0800 1150 0200 1,0	Ad	
	H 800 L 1250	P 31 0800 1250 0200 1,0	Ad	
	H 800 L 1330	P 31 0800 1330 0200 1,0	Ad	

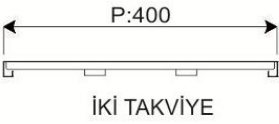
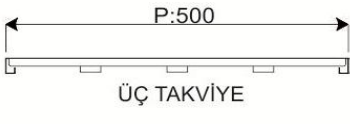
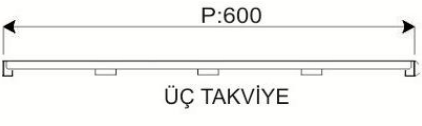

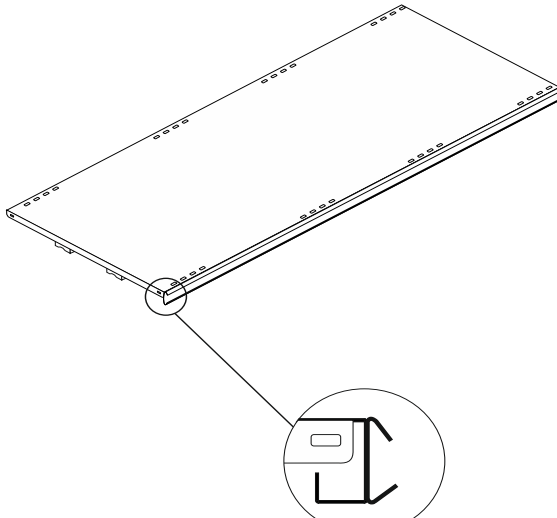

Ürün Adı ve Görseli / Product Name And The Image	Ölçü / Size HxLxP	Kod no / Code no	Br	Birim Fiyat / Unit Price
Metal Raf Konsol / Metal Shelf Bracket 	P 300 P 300 P 300	P 41 0075 2/1 0300 2,0 P 41 0075 2/1 0300 2,5 P 41 0075 2/1 0300 3,0	Ad Ad Ad	
Metal Raf Konsol / Metal Shelf Bracket 	P 300 P 300 P 300	P 41 0075 2/2 0300 2,0 P 41 0075 2/2 0300 2,5 P 41 0075 2/2 0300 3,0	Ad Ad Ad	
Metal Raf Konsol / Metal Shelf Bracket 	P 300 P 300 P 300	P 41 0100 3/1 0300 2,0 P 41 0100 3/1 0300 2,5 P 41 0100 3/1 0300 3,0	Ad Ad Ad	
Metal Raf Konsol / Metal Shelf Bracket 	P 300 P 300 P 300	P 41 0100 3/2 0300 2,0 P 41 0100 3/2 0300 2,5 P 41 0100 3/2 0300 3,0	Ad Ad Ad	
Metal Raf Konsol / Metal Shelf Bracket 	P 400 P 400	P 41 0100 3/1 0400 2,5 P 41 0100 3/1 0400 3,0	Ad Ad	
Metal Raf Konsol / Metal Shelf Bracket 	P 500 P 500	P 41 0100 3/1 0500 2,5 P 41 0100 3/1 0500 3,0	Ad Ad	

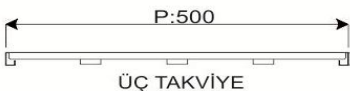

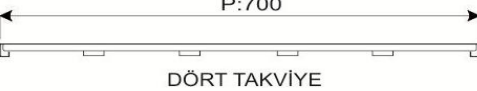
Ürün Adı ve Görseli / Product Name And The Image	Ölçü / Size HxLxP	Kod no / Code no	Br	Birim Fiyat / Unit Price
Metal Raf Konsol / Metal Shelf Bracket 	P 400 P 400 P 400	P 41 0130 4/1 0400 2,0 P 41 0130 4/1 0400 2,5 P 41 0130 4/1 0400 3,0	Ad Ad Ad	
Metal Raf Konsol / Metal Shelf Bracket 	P 500 P 500	P 41 0130 4/1 0500 2,5 P 41 0130 4/1 0500 3,0	Ad Ad	
Metal Raf Konsol / Metal Shelf Bracket 	P 600 P 600	P 41 0130 4/1 0600 2,5 P 41 0130 4/1 0600 3,0	Ad Ad	
Metal Raf Konsol / Metal Shelf Bracket 	P 400 P 400	P 41 0160 5/1 0400 2,5 P 41 0160 5/1 0400 3,0	Ad Ad	
Metal Raf Konsol / Metal Shelf Bracket 	P 500 P 500	P 41 0160 5/1 0500 2,5 P 41 0160 5/1 0500 3,0	Ad Ad	
Metal Raf Konsol / Metal Shelf Bracket 	P 600 P 600	P 41 0160 5/1 0600 2,5 P 41 0160 5/1 0600 3,0	Ad Ad	
Metal Raf Konsol / Metal Shelf Bracket 	P 700 P 700	P 41 0160 5/1 0700 2,5 P 41 0160 5/1 0700 3,0	Ad Ad	

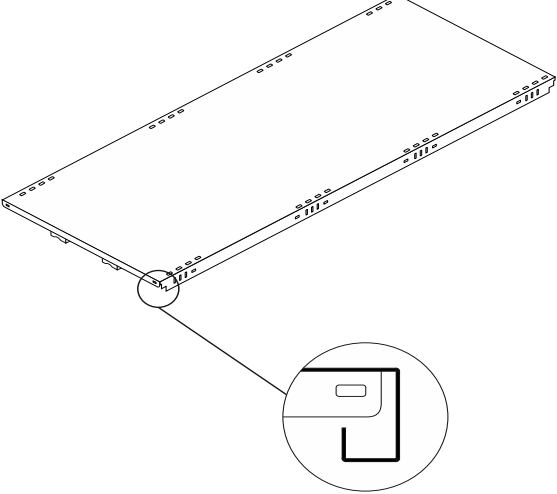
Ürün Adı ve Görseli / Product Name And The Image	Ölçü / Size HxLxP mm	Kod no / Code no	Br	Birim Fiyat / Unit Price
<p>Metal Raf / Metal Shelf</p>      	L 600 P 300	P 51 0026 0600 0300 0,7	Ad	
	L 600 P 400	P 51 0026 0600 0400 0,7	Ad	
	L 600 P 500	P 51 0026 0600 0500 0,7	Ad	
	L 600 P 600	P 51 0026 0600 0600 0,7	Ad	
	L 600 P 700	P 51 0026 0600 0700 0,7	Ad	
	L 700 P 300	P 51 0026 0700 0300 0,7	Ad	
	L 700 P 400	P 51 0026 0700 0400 0,7	Ad	
	L 700 P 500	P 51 0026 0700 0500 0,7	Ad	
	L 700 P 600	P 51 0026 0700 0600 0,7	Ad	
	L 700 P 700	P 51 0026 0700 0700 0,7	Ad	
	L 800 P 300	P 51 0026 0800 0300 0,7	Ad	
	L 800 P 400	P 51 0026 0800 0400 0,7	Ad	
	L 800 P 500	P 51 0026 0800 0500 0,7	Ad	
	L 800 P 600	P 51 0026 0800 0600 0,7	Ad	
	L 800 P 700	P 51 0026 0800 0700 0,7	Ad	
	L 900 P 300	P 51 0026 0900 0300 0,7	Ad	
	L 900 P 400	P 51 0026 0900 0400 0,7	Ad	
	L 900 P 500	P 51 0026 0900 0500 0,7	Ad	
	L 900 P 600	P 51 0026 0900 0600 0,7	Ad	
	L 900 P 700	P 51 0026 0900 0700 0,7	Ad	
	L 1000 P 300	P 51 0026 1000 0300 0,7	Ad	
	L 1000 P 400	P 51 0026 1000 0400 0,7	Ad	
	L 1000 P 500	P 51 0026 1000 0500 0,7	Ad	
	L 1000 P 600	P 51 0026 1000 0600 0,7	Ad	
	L 1000 P 700	P 51 0026 1000 0700 0,7	Ad	
	L 1150 P 300	P 51 0026 1150 0300 0,7	Ad	
	L 1150 P 400	P 51 0026 1150 0400 0,7	Ad	
	L 1150 P 500	P 51 0026 1150 0500 0,7	Ad	
	L 1150 P 600	P 51 0026 1150 0600 0,7	Ad	
	L 1150 P 700	P 51 0026 1150 0700 0,7	Ad	
	L 1250 P 300	P 51 0026 1250 0300 0,7	Ad	
	L 1250 P 400	P 51 0026 1250 0400 0,7	Ad	
	L 1250 P 500	P 51 0026 1250 0500 0,7	Ad	
	L 1250 P 600	P 51 0026 1250 0600 0,7	Ad	
	L 1250 P 700	P 51 0026 1250 0700 0,7	Ad	
	L 1330 P 300	P 51 0026 1330 0300 0,7	Ad	
	L 1330 P 400	P 51 0026 1330 0400 0,7	Ad	
	L 1330 P 500	P 51 0026 1330 0500 0,7	Ad	
	L 1330 P 600	P 51 0026 1330 0600 0,7	Ad	
	L 1330 P 700	P 51 0026 1330 0700 0,7	Ad	

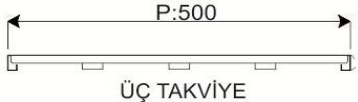
Ürün Adı ve Görseli / Product Name And The Image	Ölçü / Size HxLxP	Kod no / Code no	Br	Birim Fiyat / Unit Price
<p>Metal Raf / Metal Shelf</p>      	L 600 P 300	P 51 0026 0600 0300 0,8	Ad	
	L 600 P 400	P 51 0026 0600 0400 0,8	Ad	
	L 600 P 500	P 51 0026 0600 0500 0,8	Ad	
	L 600 P 600	P 51 0026 0600 0600 0,8	Ad	
	L 600 P 700	P 51 0026 0600 0700 0,8	Ad	
	L 700 P 300	P 51 0026 0700 0300 0,8	Ad	
	L 700 P 400	P 51 0026 0700 0400 0,8	Ad	
	L 700 P 500	P 51 0026 0700 0500 0,8	Ad	
	L 700 P 600	P 51 0026 0700 0600 0,8	Ad	
	L 700 P 700	P 51 0026 0700 0700 0,8	Ad	
	L 800 P 300	P 51 0026 0800 0300 0,8	Ad	
	L 800 P 400	P 51 0026 0800 0400 0,8	Ad	
	L 800 P 500	P 51 0026 0800 0500 0,8	Ad	
	L 800 P 600	P 51 0026 0800 0600 0,8	Ad	
	L 800 P 700	P 51 0026 0800 0700 0,8	Ad	
	L 900 P 300	P 51 0026 0900 0300 0,8	Ad	
	L 900 P 400	P 51 0026 0900 0400 0,8	Ad	
	L 900 P 500	P 51 0026 0900 0500 0,8	Ad	
	L 900 P 600	P 51 0026 0900 0600 0,8	Ad	
	L 900 P 700	P 51 0026 0900 0700 0,8	Ad	
	L 1000 P 300	P 51 0026 1000 0300 0,8	Ad	
	L 1000 P 400	P 51 0026 1000 0400 0,8	Ad	
	L 1000 P 500	P 51 0026 1000 0500 0,8	Ad	
	L 1000 P 600	P 51 0026 1000 0600 0,8	Ad	
	L 1000 P 700	P 51 0026 1000 0700 0,8	Ad	
	L 1150 P 300	P 51 0026 1150 0300 0,8	Ad	
	L 1150 P 400	P 51 0026 1150 0400 0,8	Ad	
	L 1150 P 500	P 51 0026 1150 0500 0,8	Ad	
	L 1150 P 600	P 51 0026 1150 0600 0,8	Ad	
	L 1150 P 700	P 51 0026 1150 0700 0,8	Ad	
	L 1250 P 300	P 51 0026 1250 0300 0,8	Ad	
	L 1250 P 400	P 51 0026 1250 0400 0,8	Ad	
	L 1250 P 500	P 51 0026 1250 0500 0,8	Ad	
	L 1250 P 600	P 51 0026 1250 0600 0,8	Ad	
	L 1250 P 700	P 51 0026 1250 0700 0,8	Ad	
L 1330 P 300	P 51 0026 1330 0300 0,8	Ad		
L 1330 P 400	P 51 0026 1330 0400 0,8	Ad		
L 1330 P 500	P 51 0026 1330 0500 0,8	Ad		
L 1330 P 600	P 51 0026 1330 0600 0,8	Ad		
L 1330 P 700	P 51 0026 1330 0700 0,8	Ad		

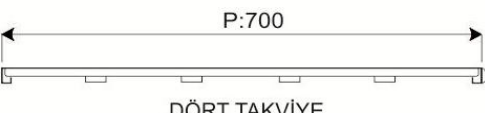

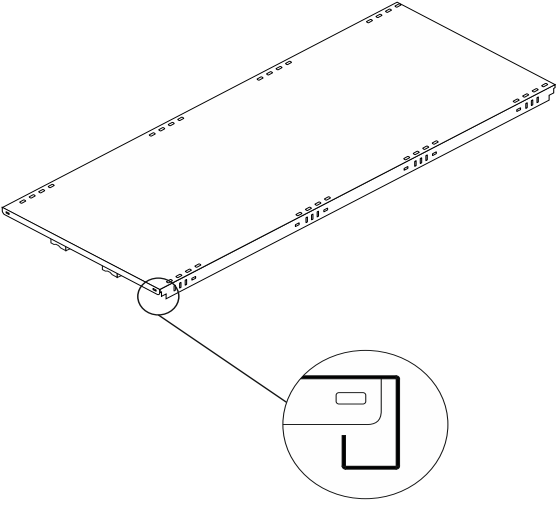
Ürün Adı ve Görseli / Product Name And The Image	Ölçü / Size HxLxP	Kod no / Code no	Br	Birim Fiyat / Unit Price
<p>Metal Raf / Metal Shelf</p>      	L 600 P 300	P 52 0026 0600 0300 0,7	Ad	
	L 600 P 400	P 52 0026 0600 0400 0,7	Ad	
	L 600 P 500	P 52 0026 0600 0500 0,7	Ad	
	L 600 P 600	P 52 0026 0600 0600 0,7	Ad	
	L 600 P 700	P 52 0026 0600 0700 0,7	Ad	
	L 700 P 300	P 52 0026 0700 0300 0,7	Ad	
	L 700 P 400	P 52 0026 0700 0400 0,7	Ad	
	L 700 P 500	P 52 0026 0700 0500 0,7	Ad	
	L 700 P 600	P 52 0026 0700 0600 0,7	Ad	
	L 700 P 700	P 52 0026 0700 0700 0,7	Ad	
	L 800 P 300	P 52 0026 0800 0300 0,7	Ad	
	L 800 P 400	P 52 0026 0800 0400 0,7	Ad	
	L 800 P 500	P 52 0026 0800 0500 0,7	Ad	
	L 800 P 600	P 52 0026 0800 0600 0,7	Ad	
	L 800 P 700	P 52 0026 0800 0700 0,7	Ad	
	L 900 P 300	P 52 0026 0900 0300 0,7	Ad	
	L 900 P 400	P 52 0026 0900 0400 0,7	Ad	
	L 900 P 500	P 52 0026 0900 0500 0,7	Ad	
	L 900 P 600	P 52 0026 0900 0600 0,7	Ad	
	L 900 P 700	P 52 0026 0900 0700 0,7	Ad	
	L 1000 P 300	P 52 0026 1000 0300 0,7	Ad	
	L 1000 P 400	P 52 0026 1000 0400 0,7	Ad	
	L 1000 P 500	P 52 0026 1000 0500 0,7	Ad	
	L 1000 P 600	P 52 0026 1000 0600 0,7	Ad	
	L 1000 P 700	P 52 0026 1000 0700 0,7	Ad	
	L 1150 P 300	P 52 0026 1150 0300 0,7	Ad	
	L 1150 P 400	P 52 0026 1150 0400 0,7	Ad	
	L 1150 P 500	P 52 0026 1150 0500 0,7	Ad	
	L 1150 P 600	P 52 0026 1150 0600 0,7	Ad	
	L 1150 P 700	P 52 0026 1150 0700 0,7	Ad	
	L 1250 P 300	P 52 0026 1250 0300 0,7	Ad	
	L 1250 P 400	P 52 0026 1250 0400 0,7	Ad	
	L 1250 P 500	P 52 0026 1250 0500 0,7	Ad	
	L 1250 P 600	P 52 0026 1250 0600 0,7	Ad	
	L 1250 P 700	P 52 0026 1250 0700 0,7	Ad	
	L 1330 P 300	P 52 0026 1330 0300 0,7	Ad	
	L 1330 P 400	P 52 0026 1330 0400 0,7	Ad	
	L 1330 P 500	P 52 0026 1330 0500 0,7	Ad	
	L 1330 P 600	P 52 0026 1330 0600 0,7	Ad	
	L 1330 P 700	P 52 0026 1330 0700 0,7	Ad	

Ürün Adı ve Görseli / Product Name And The Image	Ölçü / Size HxLxP	Kod no / Code no	Br	Birim Fiyat / Unit Price
<p>Metal Raf / Metal Shelf</p>  <p>P:300 TEK TAKVIYE</p> <p>P:400 İKİ TAKVIYE</p> <p>P:500 ÜÇ TAKVIYE</p> <p>P:600 ÜÇ TAKVIYE</p> <p>P:700 DÖRT TAKVIYE</p>	L 600 P 300	P 52 0026 0600 0300 0,8	Ad	
	L 600 P 400	P 52 0026 0600 0400 0,8	Ad	
	L 600 P 500	P 52 0026 0600 0500 0,8	Ad	
	L 600 P 600	P 52 0026 0600 0600 0,8	Ad	
	L 600 P 700	P 52 0026 0600 0700 0,8	Ad	
	L 700 P 300	P 52 0026 0700 0300 0,8	Ad	
	L 700 P 400	P 52 0026 0700 0400 0,8	Ad	
	L 700 P 500	P 52 0026 0700 0500 0,8	Ad	
	L 700 P 600	P 52 0026 0700 0600 0,8	Ad	
	L 700 P 700	P 52 0026 0700 0700 0,8	Ad	
	L 800 P 300	P 52 0026 0800 0300 0,8	Ad	
	L 800 P 400	P 52 0026 0800 0400 0,8	Ad	
	L 800 P 500	P 52 0026 0800 0500 0,8	Ad	
	L 800 P 600	P 52 0026 0800 0600 0,8	Ad	
	L 800 P 700	P 52 0026 0800 0700 0,8	Ad	
	L 900 P 300	P 52 0026 0900 0300 0,8	Ad	
	L 900 P 400	P 52 0026 0900 0400 0,8	Ad	
	L 900 P 500	P 52 0026 0900 0500 0,8	Ad	
	L 900 P 600	P 52 0026 0900 0600 0,8	Ad	
	L 900 P 700	P 52 0026 0900 0700 0,8	Ad	
	L 1000 P 300	P 52 0026 1000 0300 0,8	Ad	
	L 1000 P 400	P 52 0026 1000 0400 0,8	Ad	
	L 1000 P 500	P 52 0026 1000 0500 0,8	Ad	
	L 1000 P 600	P 52 0026 1000 0600 0,8	Ad	
	L 1000 P 700	P 52 0026 1000 0700 0,8	Ad	
	L 1150 P 300	P 52 0026 1150 0300 0,8	Ad	
	L 1150 P 400	P 52 0026 1150 0400 0,8	Ad	
	L 1150 P 500	P 52 0026 1150 0500 0,8	Ad	
	L 1150 P 600	P 52 0026 1150 0600 0,8	Ad	
	L 1150 P 700	P 52 0026 1150 0700 0,8	Ad	
	L 1250 P 300	P 52 0026 1250 0300 0,8	Ad	
	L 1250 P 400	P 52 0026 1250 0400 0,8	Ad	
	L 1250 P 500	P 52 0026 1250 0500 0,8	Ad	
	L 1250 P 600	P 52 0026 1250 0600 0,8	Ad	
	L 1250 P 700	P 52 0026 1250 0700 0,8	Ad	
	L 1330 P 300	P 52 0026 1330 0300 0,8	Ad	
	L 1330 P 400	P 52 0026 1330 0400 0,8	Ad	
	L 1330 P 500	P 52 0026 1330 0500 0,8	Ad	
	L 1330 P 600	P 52 0026 1330 0600 0,8	Ad	
	L 1330 P 700	P 52 0026 1330 0700 0,8	Ad	

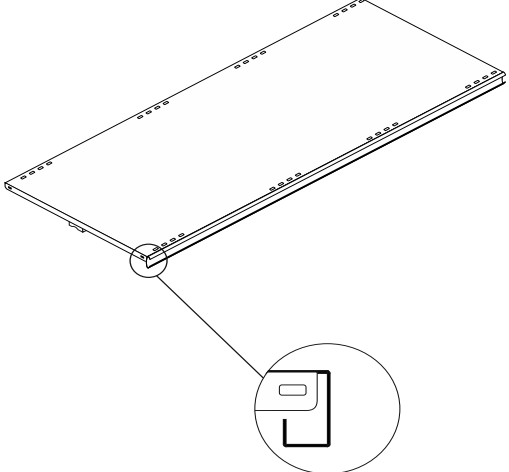

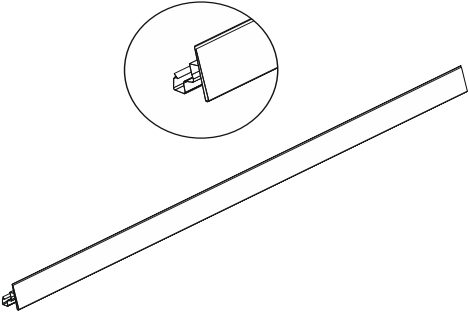
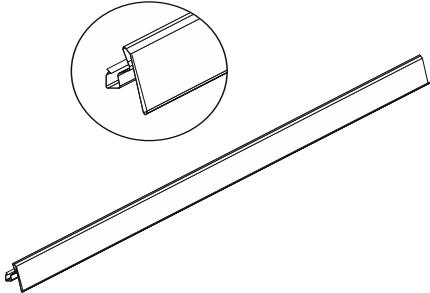
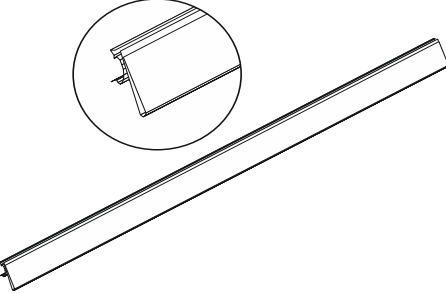
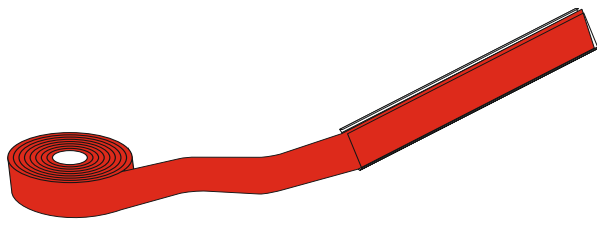
Ürün Adı ve Görseli / Product Name And The Image	Ölçü / Size HxLxP	Kod no / Code no	Br	Birim Fiyat / Unit Price
<p>Metal Raf / Metal Shelf</p>  <p>P:300 TEK TAKVIYE</p> <p>P:400 TEK TAKVIYE</p> <p>P:500 İKİ TAKVIYE</p> <p>P:600 İKİ TAKVIYE</p> <p>P:700 ÜÇ TAKVIYE</p>	L 600 P 300	P 53 0026 0600 0300 0,7	Ad	
	L 600 P 400	P 53 0026 0600 0400 0,7	Ad	
	L 600 P 500	P 53 0026 0600 0500 0,7	Ad	
	L 600 P 600	P 53 0026 0600 0600 0,7	Ad	
	L 600 P 700	P 53 0026 0600 0700 0,7	Ad	
	L 700 P 300	P 53 0026 0700 0300 0,7	Ad	
	L 700 P 400	P 53 0026 0700 0400 0,7	Ad	
	L 700 P 500	P 53 0026 0700 0500 0,7	Ad	
	L 700 P 600	P 53 0026 0700 0600 0,7	Ad	
	L 700 P 700	P 53 0026 0700 0700 0,7	Ad	
	L 800 P 300	P 53 0026 0800 0300 0,7	Ad	
	L 800 P 400	P 53 0026 0800 0400 0,7	Ad	
	L 800 P 500	P 53 0026 0800 0500 0,7	Ad	
	L 800 P 600	P 53 0026 0800 0600 0,7	Ad	
	L 800 P 700	P 53 0026 0800 0700 0,7	Ad	
	L 900 P 300	P 53 0026 0900 0300 0,7	Ad	
	L 900 P 400	P 53 0026 0900 0400 0,7	Ad	
	L 900 P 500	P 53 0026 0900 0500 0,7	Ad	
	L 900 P 600	P 53 0026 0900 0600 0,7	Ad	
	L 900 P 700	P 53 0026 0900 0700 0,7	Ad	
	L 1000 P 300	P 53 0026 1000 0300 0,7	Ad	
	L 1000 P 400	P 53 0026 1000 0400 0,7	Ad	
	L 1000 P 500	P 53 0026 1000 0500 0,7	Ad	
	L 1000 P 600	P 53 0026 1000 0600 0,7	Ad	
	L 1000 P 700	P 53 0026 1000 0700 0,7	Ad	

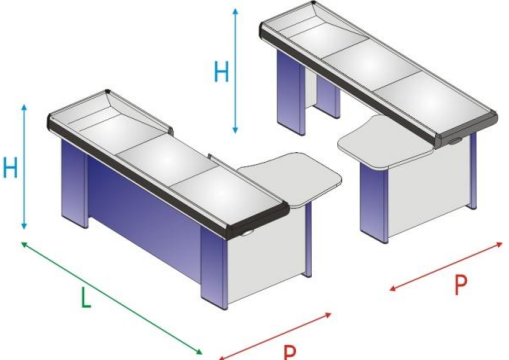
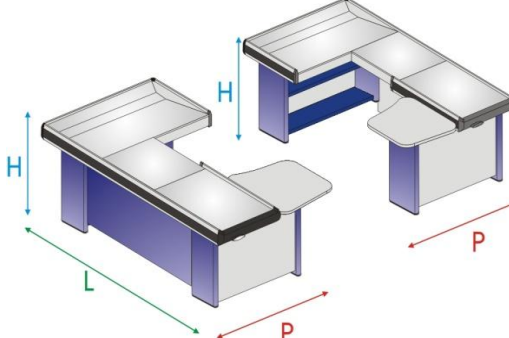
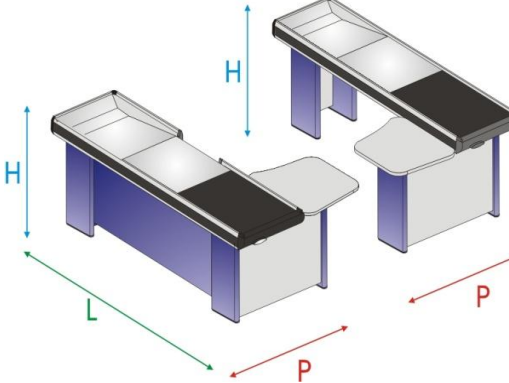
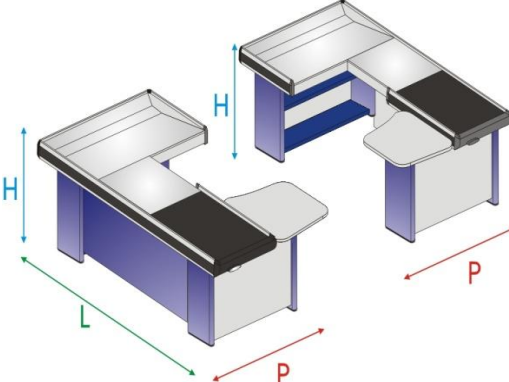

Ürün Adı ve Görseli / Product Name And The Image	Ölçü / Size HxLxP	Kod no / Code no	Br	Birim Fiyat / Unit Price
Plastik Etiket (Sabit) / Price Holder (Hard) 	L 600 mm L 700 mm L 800 mm L 900 mm L 1000 mm L 1150 mm L 1250 mm L 1330 mm	79 PEP 52071 600 79 PEP 52071 700 79 PEP 52071 800 79 PEP 52071 900 79 PEP 52071 1000 79 PEP 52071 1150 79 PEP 52071 1250 79 PEP 52071 1330	Ad Ad Ad Ad Ad Ad Ad Ad	
Plastik Etiket (Hareketli) / Price Holder (moving) 	L 600 L 700 L 800 L 900 L 1000 L 1150 L 1250 L 1330	79 PEP 52055 600 79 PEP 52055 700 79 PEP 52055 800 79 PEP 52055 900 79 PEP 52055 1000 79 PEP 52055 1150 79 PEP 52055 1250 79 PEP 52055 1330	Ad Ad Ad Ad Ad Ad Ad Ad	
Plastik Etiket (C Profile Geçen Hareketli) Price Holder (C Profile Plug moving) 	L 600 L 700 L 800 L 900 L 1000 L 1150 L 1250 L 1330	79 PEP 54011 600 79 PEP 54011 700 79 PEP 54011 800 79 PEP 54011 900 79 PEP 54011 1000 79 PEP 54011 1150 79 PEP 54011 1250 79 PEP 54011 1330	Ad Ad Ad Ad Ad Ad Ad Ad	
Rulo Şerit / Colored Price Strip İnsert 	L 600 L 700 L 800 L 900 L 1000 L 1150 L 1250 L 1330  L 600 L 700 L 800 L 900 L 1000 L 1150 L 1250 L 1330	78 PES 37 600 0,25 78 PES 37 700 0,25 78 PES 37 800 0,25 78 PES 37 900 0,25 78 PES 37 1000 0,25 78 PES 37 1150 0,25 78 PES 37 1250 0,25 78 PES 37 1330 0,25  78 PES 37 600 0,40 78 PES 37 700 0,40 78 PES 37 800 0,40 78 PES 37 900 0,40 78 PES 37 1000 0,40 78 PES 37 1150 0,40 78 PES 37 1250 0,40 78 PES 37 1330 0,40	Ad Ad Ad Ad Ad Ad Ad Ad  Ad Ad Ad Ad Ad Ad Ad	

Ürün Adı ve Görseli / Product Name And The Image	Ölçü / Size HxLxP	Kod no / Code no	Br	Birim Fiyat / Unit Price
Gondol Başı Yanı 	H 1950 L 470 P 250A 200*6  H 1950 L 570 P 250A 200*6	FSM GBY 1950  FSM GBY 1950	TK  TK	
Gondol Başı Yanı 	H 1700 L 470 P 250A 200*6  H 1700 L 570 P 250A 200*6	FSM GBY 1700  FSM GBY 1700	TK  TK	
Gondol Başı Yanı 	H 1400 L 470 P 250A 200*6  H 1400 L 570 P 250A 200*6	FSM GBY 1400  FSM GBY 1400	TK  TK	
Gondol Başı Yanı RAFI 	L 470 P 200  L 570 P 200	FSM GBY 470  FSM GBY 570	TK  TK	

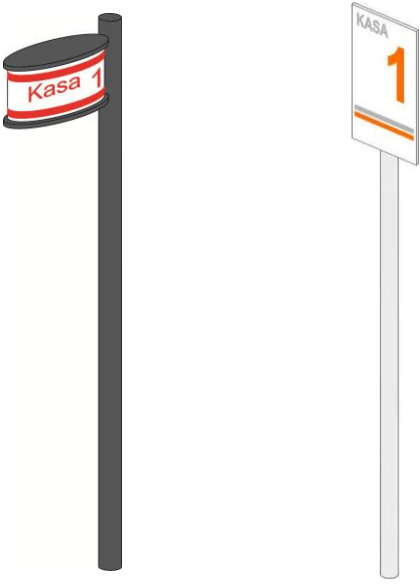
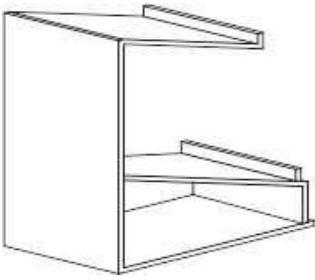
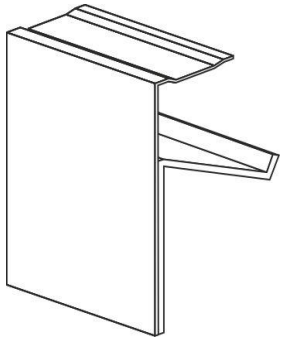

Ürün Adı ve Görseli / Product Name And The Image	Ölçü / Size HxLxP	Kod no / Code no	Br	Birim Fiyat / Unit Price
<b>Kasa Altlığı L-Tipi Bantsız</b> <b>Checkout L-Type Tapeless</b> 	L 1600 L 1900 L 2100 L 2300  L 1600 L 1900 L 2100 L 2300	KA 2008 LTP 1600 L KA 2008 LTP 1900 L KA 2008 LTP 2100 L KA 2008 LTP 2300 L  KA 2008 LTP 1600 R KA 2008 LTP 1900 R KA 2008 LTP 2100 R KA 2008 LTP 2300 R	Ad Ad Ad Ad  Ad Ad Ad Ad	
<b>Kasa Altlığı U-Tipi Bantsız</b> <b>Checkout U-Type Tapeless</b> 	L 1900 L 2100 L 2300  L 1900 L 2100 L 2300	KA 2008 UTP 1900 L KA 2008 UTP 2100 L KA 2008 UTP 2300 L  KA 2008 UTP 1900 R KA 2008 UTP 2100 R KA 2008 UTP 2300 R	Ad Ad Ad  Ad Ad Ad	
<b>Kasa Altlığı L-Tipi Bantlı</b> <b>Checkout L-Type With transportband</b> 	L 1900 L 2100 L 2300 L 2500 L 2700 L 2900  L 1900 L 2100 L 2300 L 2500 L 2700 L 2900	KAB 2008 LTP 1900 L KAB 2008 LTP 2100 L KAB 2008 LTP 2300 L KAB 2008 LTP 2500 L KAB 2008 LTP 2700 L KAB 2008 LTP 2900 L  KAB 2008 LTP 1900 R KAB 2008 LTP 2100 R KAB 2008 LTP 2300 R KAB 2008 LTP 2500 R KAB 2008 LTP 2700 R KAB 2008 LTP 2900 R	Ad Ad Ad Ad Ad Ad  Ad Ad Ad Ad Ad Ad	
<b>Kasa Altlığı U-Tipi Bantlı</b> <b>Checkout U-Type With transportband</b> 	L 1900 L 2100 L 2300 L 2500 L 2700 L 2900  L 1900 L 2100 L 2300 L 2500 L 2700 L 2900	KAB 2008 UTP 1900 L KAB 2008 UTP 2100 L KAB 2008 UTP 2300 L KAB 2008 UTP 2300 L KAB 2008 UTP 2300 L KAB 2008 UTP 2300 L  KAB 2008 UTP 1900 R KAB 2008 UTP 2100 R KAB 2008 UTP 2300 R KAB 2008 UTP 2300 R KAB 2008 UTP 2300 R KAB 2008 UTP 2300 R	Ad Ad Ad Ad Ad Ad  Ad Ad Ad Ad Ad Ad	

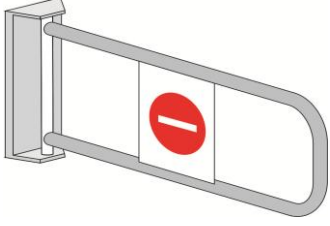
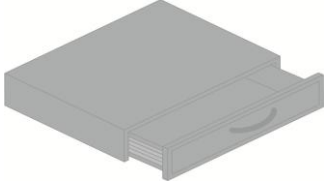
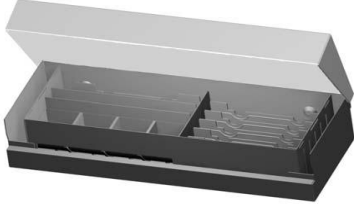

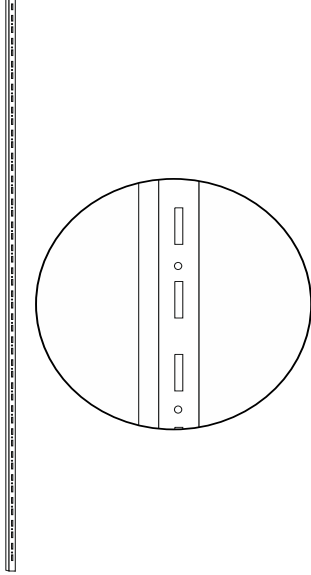
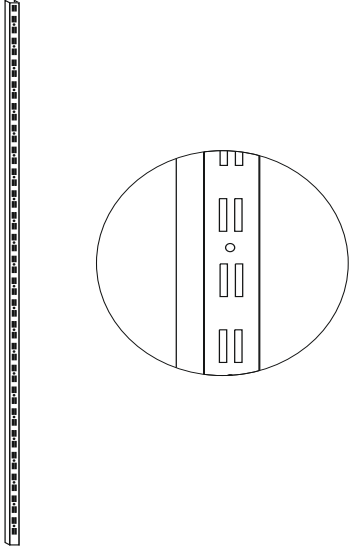
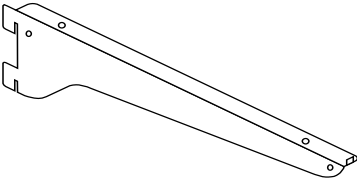

Ürün Adı ve Görseli / Product Name And The Image	Ölçü / Size HxLxP	Kod no / Code no	Br	Birim Fiyat / Unit Price
<p>Kasa Kablo Direği &amp; Numaratör Lambası Checkout Pipe Cable &amp; Flashing Identification Lamp</p> 	Standart	KA AKS 010	TK	
<p>Pos ve Telefon Pleksi Plexi For Credit Card And Telephone</p> 	Standart	KA AKS 020	Ad	
<p>Scanner Koruyucu ve Klavyelik Scanner Protector And Keyboard Holder</p> 	Standart	KA AKS 021	Tk	

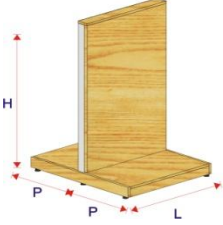
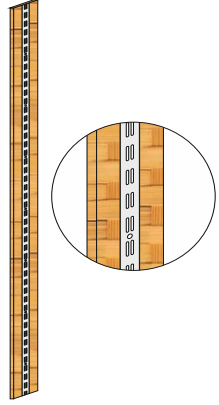
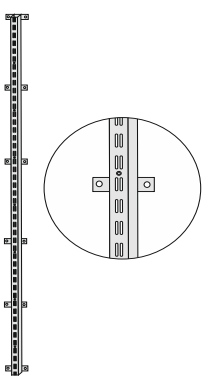

Ürün Adı ve Görseli / Product Name And The Image	Ölçü / Size HxLxP	Kod no / Code no	Br	Birim Fiyat / Unit Price
<p>Kasa Kolidor Kapısı Checkout Closures</p> 	Standart	KA ASK 040	Ad	
<p>Para Kutusu Manuel Flip-Lid Cash Drawer</p> 	Standart	KA AKS 001 M	Ad	
<p>Para Kutusu Otomatik Flip-Lid Cash Drawer</p> 	Standart	KA AKS 001 OT	Ad	
<p>Kasa Önü Gondolu Checkout Gondola</p> 	Standart	KA AKS 050	Tk	
<p>Kasa Önü Standı Checkout Gondola Stand</p> 	Standart	KA AKS 051	Ad	

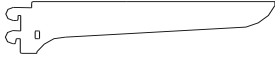
Ürün Adı ve Görseli / Product Name And The Image	Ölçü / Size HxLxP	Kod no / Code no	Br	Birim Fiyat / Unit Price
Suntalam Ray Tek Kanallı suntalam Wall-Mount Doot Single 	H 2000	TAS 101 200	Ad	
	H 2500	TAS 101 250	Ad	
Suntalam Destek Çift Kanallı Suntalam Wall-Mount Foot Double 	H 2000	TAS 102 200	Ad	
	H 2500	TAS 102 250	Ad	
Suntalam Destek / Suntalam Console 	P 200	TAS 111 020	Ad	
	P 250	TAS 111 025	Ad	
	P 300	TAS 111 030	Ad	
	P 350	TAS 111 035	Ad	
	P 400	TAS 111 040	Ad	

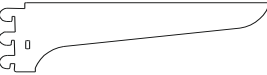

Ürün Adı ve Görseli / Product Name And The Image	Ölçü / Size HxLxP	Kod no / Code no	Br	Birim Fiyat / Unit Price
Ahşap Duvar Üniteleri Klasik Classic Wooden Wall Units 	Tasarım	TAS 200 001	TK	
Ahşap Orta Üniteleri Klasik Classic Wood Middle Units 	Tasarım	TAS 200 002	TK	
Ahşap Orta Üniteleri Klasik Classic Wood Middle Units 	Tasarım	TAS 200 003	TK	
Lüks Dekor Sistem Ayağı Aksesuarlı Foot Wall Mounting System 	H 200 H 250	TAS 2011 200 TAS 2011 250	Ad Ad	
Lüks Dekor Sistem Ayağı Foot Wall Mounting System  <p>Lx Sistem Metal Raf için P 51 - 52 - 53 'ye Bakınız.</p>	H 200 H 250	TAS 212 200 TAS 212 250	Ad Ad	

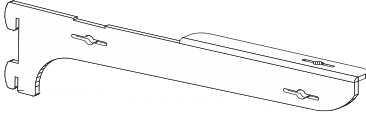
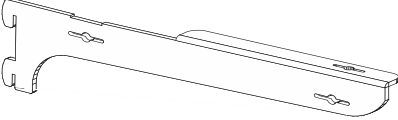
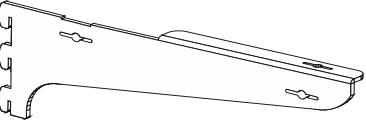
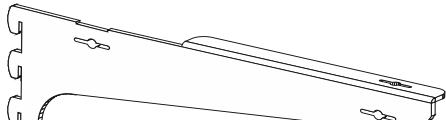
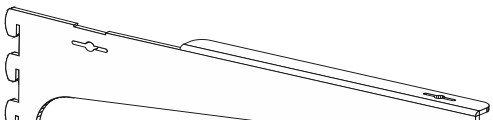
Ürün Adı ve Görseli / Product Name And The Image	Ölçü / Size HxLxP	Kod no / Code no	Br	Birim Fiyat / Unit Price
Ahşap Raf Konsol / Wooden Shelf Bracket 	P 300	TAS 221 030 2/1	Ad	
Ahşap Raf Konsol / Wooden Shelf Bracket 	P 350	TAS 221 035 2/1	Ad	
Ahşap Raf Konsol / Wooden Shelf Bracket 	P 300	TAS 221 030 3/1	Ad	
Ahşap Raf Konsol / Wooden Shelf Bracket 	P 400	TAS 221 035 3/1	Ad	
Ahşap Raf Konsol / Wooden Shelf Bracket 	P 500	TAS 221 050 3/1	Ad	

Ürün Adı ve Görseli / Product Name And The Image	Ölçü / Size HxLxP	Kod no / Code no	Br	Birim Fiyat / Unit Price
Cam Raf Konsol / Glass Shelf Bracket 	P 300	TAS 222 030 2/1	Ad	
Cam Raf Konsol / Glass Shelf Bracket 	P 350	TAS 222 035 2/1	Ad	
Cam Raf Konsol / Glass Shelf Bracket 	P 300	TAS 222 030 3/1	Ad	
Cam Raf Konsol / Glass Shelf Bracket 	P 400	TAS 222 040 3/1	Ad	
Cam Raf Konsol / Glass Shelf Bracket 	P 500	TAS 222 050 3/1	Ad	

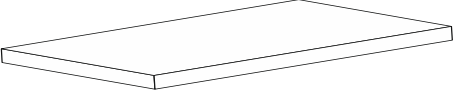
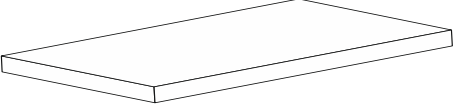
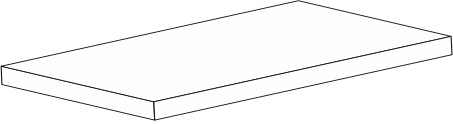
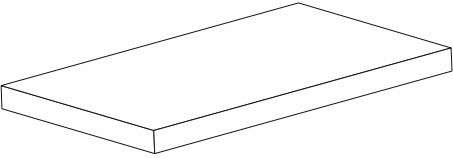
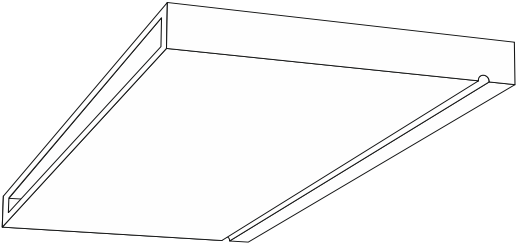
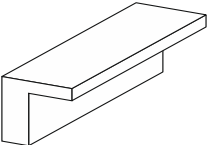
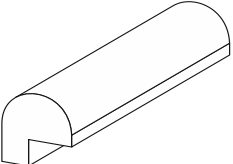
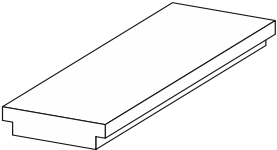

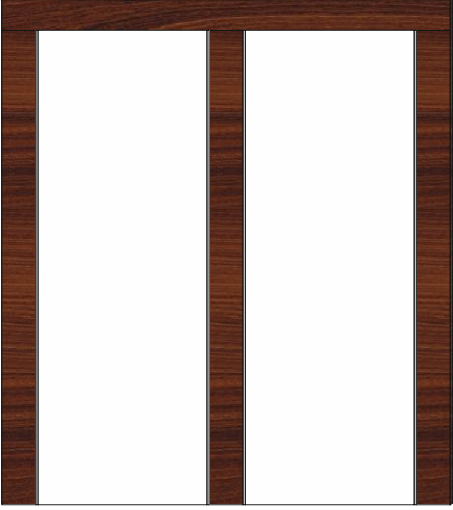

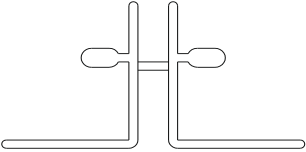
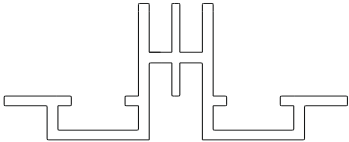

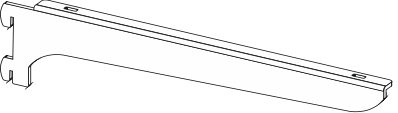
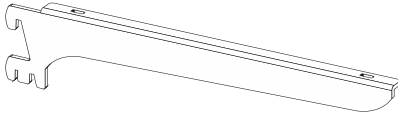
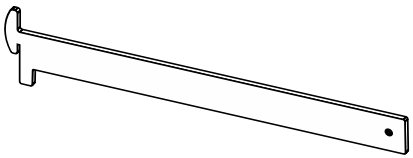
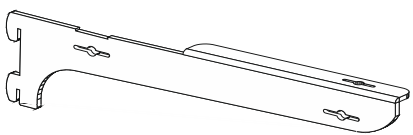
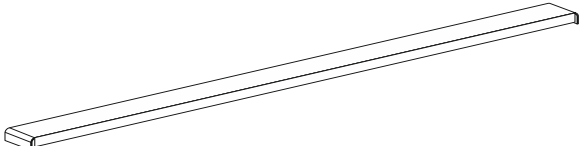
Ürün Adı ve Görseli / Product Name And The Image	Ölçü / Size HxLxP	Kod no / Code no	Br	Birim Fiyat / Unit Price
Ahşap Raf (4 Taraflı Pcvli) / Wood Shelf 	H 18	TAS 224 001	M2	
Ahşap Raf (4 Taraflı Pcvli) / Wood Shelf 	H 25	TAS 224 002	M2	
Ahşap Raf (4 Taraflı Pcvli) / Wood Shelf 	H 30	TAS 224 003	M2	
Ahşap Raf (4 Taraflı Pcvli) / Wood Shelf 	H 36	TAS 224 004	M2	
Ahşap Raf (Lake Boyalı) / Wood Shelf  Konsol için <b>TR 051</b> 'e Bakınız	H 70 L 1000 P 400	TAS 224 005	AD	
Ahşap Profili / Wood Profile 	Düz	65 AGT 1041	Mt	
Ahşap Profili / Wood Profile 	Oval	65 AGT 1044	Mt	
Ahşap Profili / Wood Profile 	Kalınlaştırma	65 AGT LP 60	Mt	

Ürün Adı ve Görseli / Product Name And The Image	Ölçü / Size HxLxP	Kod no / Code no	Br	Birim Fiyat / Unit Price
Butik Duvar Üniteleri / Boutique Wall Units 	DuvarTasarım	TAS 300 001	TK	
Butik Orta Üniteleri / Boutique Middle Units 	Tasarım	TAS 300 004	TK	
Alüminyum Ayak Tekli / Aluminium Leg Singles 	H 2500 H 3000	TAS 311 250 TAS 311 300	Mt Mt	
Alüminyum Ayak Çiftli / Aluminium Leg Double 	H 2500 H 3000	TAS 312 250 TAS 312 300	Mt Mt	

Ürün Adı ve Görseli / Product Name And The Image	Ölçü / Size HxLxP	Kod no / Code no	Br	Birim Fiyat / Unit Price
Alm.Ray Konsol Ahşap İçin / Aluminum Rail Bracket 	P 300 P 350	TAS 321 030 2/1 TAS 321 035 2/1	Ad Ad	
Alm.Ray Konsol Ahşap İçin / Aluminum Rail Bracket 	P 300 P 350	TAS 321 030 2/2 TAS 321 035 2/2	Ad Ad	
Alm.Ray Konsol Ahşap İçin / Aluminum Rail Bracket 	P 300 P 350	TAS 321 030 1/1 TAS 321 035 1/1	Ad Ad	
Alm.Ray Konsol Cam Raf İçin Aluminum Rail Glass Bracket 	P 200 P 250 P 300 P 350	TAS 322 020 2/1 TAS 322 025 2/1 TAS 322 030 2/1 TAS 322 035 2/1	Ad Ad Ad Ad	
Alm.Ray Konsol Cam Raf İçin Travers Glass Shelf Travers 	P 60 P 70 P 80 P 90 P 100	TAS 323 060 TAS 323 070 TAS 323 080 TAS 323 090 TAS 323 100	Ad Ad Ad Ad Ad	

Ürün Adı ve Görseli / Product Name And The Image	Ölçü / Size HxLxP	Kod no / Code no	Br	Birim Fiyat / Unit Price
Unlu Mamüller Duvar Üniteleri Klasik Bakery Products Wall Units 	Tasarım	TAS 410 001	Tk	
Unlu Mamüller Duvar Üniteleri Logolu Bakery Products Wall Units 	Tasarım	TAS 420 001	Tk	
Unlu Mamüller Duvar Üniteleri Yeni Bakery Products Wall Units 	Tasarım	TAS 430 001	Tk	
Unlu Mamüller Orta Üniteleri Bakery Products Medium Units 	Tasarım	TAS 440 001	Tk	
Unlu Mamüller Ekmek Dolabı Bread Bakery Products 	Tasarım	TAS 440 002	Tk	

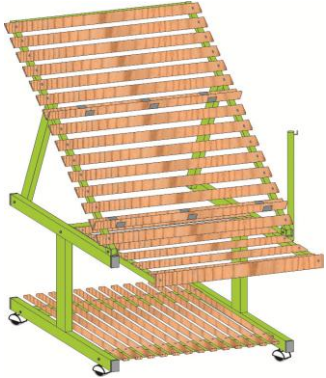

Ürün Adı ve Görseli / Product Name And The Image	Ölçü / Size HxLxP	Kod no / Code no	Br	Birim Fiyat Unit Price
<p>Manav Duvar Üniteleri Ahşap Lambiri Grocer Wall Units Wood Paneling</p> 	<p>Duvar</p> <p>Tek yönlü</p> <p>Çift yönlü</p>	<p>TAS 510 001</p> <p>TAS 510 002</p> <p>TAS 510 003</p>	<p>M2</p> <p>M2</p> <p>M2</p>	
<p>Manav Duvar Üniteleri Metal Tek Katlı Grocer Wall Units Metal Single Story</p> 	<p>Tasarım L:1200</p>	<p>TAS 520 001</p>	<p>TK</p>	
<p>Manav Duvar Üniteleri Metal Çift Katlı Grocer Wall Units Metal Double Layer</p> 	<p>Tasarım L:1200</p>	<p>TAS 530 001</p>	<p>TK</p>	
<p>Manav Orta Üniteleri Metal Tek Yönlü The only way Grocer Middle Units</p> 	<p>Tasarım L:1200</p>	<p>TAS 530 002</p>	<p>TK</p>	
<p>Manav Orta Üniteleri Metal Çift Yönlü Grocer Middle Units Bi-Directional</p> 	<p>Tasarım L:1200</p>	<p>TAS 530 003</p>	<p>TK</p>	



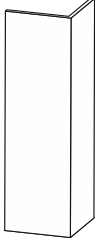
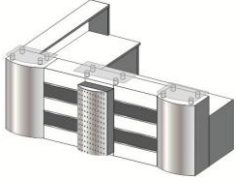
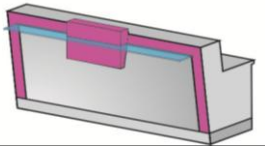
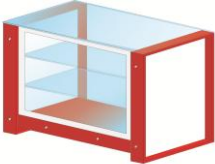

Ürün Adı ve Görseli / Product Name And The Image	Ölçü / Size HxLxP	Kod no / Code no	Br	Birim Fiyat Unit Price
<p>Özel Manav / Specialty Grocer</p> 	Tasarım	TAS 550 001	TK	
<p>Özel Manav / Specialty Grocer</p> 	Tasarım L:1200	TAS 560 001	TK	
<p>Özel Manav / Specialty Grocer</p> 	Tasarım L:1200	TAS 570 001	TK	
<p>Manav Plastik Kasa / Grocer Plastic Box</p> 	150*400*600	TAS 590 001	AD	

Ürün Adı ve Görseli / Product Name And The Image	Ölçü / Size HxLxP	Kod no / Code no	Br	Birim Fiyat / Unit Price
Paletler Ahşap / Wooden pallets 	150*800*1200 150*1000*1200	TAS 600 002 TAS 600 003	Ad Ad	
Paletler Plastik / Plastic pallets 	150*800*1200 150*1000*1200	TAS 600 004 TAS 600 005	Ad Ad	
Podyumlar / Pallets 	Tasarım	TAS 601 002	Ad	
Podyumlar İçi Metal İskeletli Internal Metal Frame Pallets 	Tasarım	TAS 601 003	Ad	
Podyumlar / Pallets 	Tasarım	TAS 601 004	Ad	
Podyumlar / Pallets 	Tasarım	TAS 601 005	Ad	



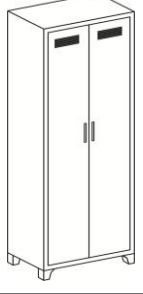
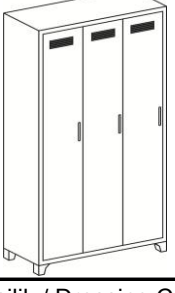

Ürün Adı ve Görseli / Product Name And The Image	Ölçü / Size HxLxP	Kod no / Code no	Br	Birim Fiyat / Unit Price
Orta Standlar / Medium Stands 	Tasarım	TAS 602 002	Mt	
Orta Masalar / Medium Furniture 	Tasarım 750*1300*800	TAS 602 003	AD	
Orta Zigonlar 5 Lİ / Middle Zigon 	Tasarım	TAS 602 004		
Terazi bankaları / Wooden Table 	Tasarım	TAS 602 005	Ad	

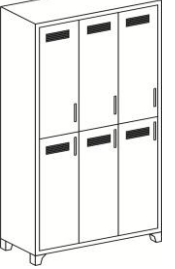



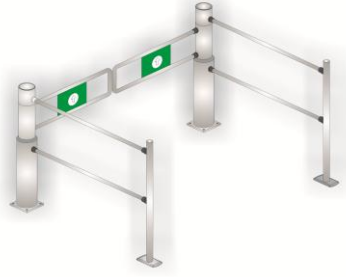
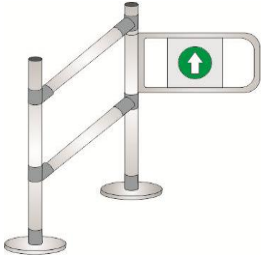
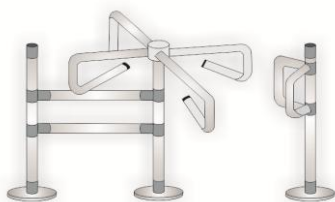

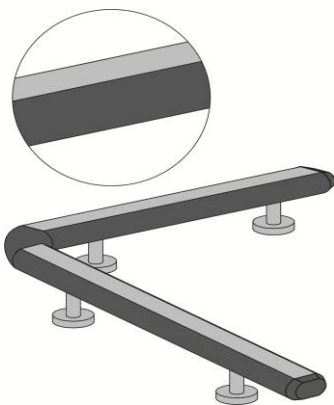
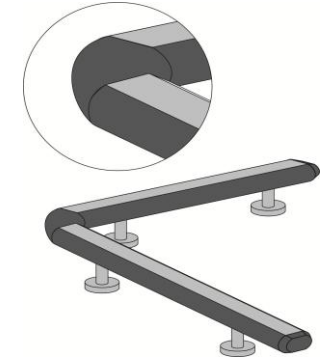

Ürün Adı ve Görseli / Product Name And The Image	Ölçü / Size HxLxP	Kod no / Code no	Br	Birim Fiyat / Unit Price
Ahşap Sütunlar / Wood Columns 	Tasarım	TAS 603 002	Ad	
Köşe Kaplamalar / Coatings corner 	Tasarım	TAS 603 003	Ad	
Kasa Bankoları / Sales Desk 	Tasarım Tasarım	TAS 604 002 TAS 604 003	MT MT	
Danışma Bankoları / Customer Service Desk 	Tasarım Tasarım	TAS 604 004 TAS 604 005	MT MT	
Servis Bankoları / Service Desk 	Tasarım	TAS 604 006	MT	
Alüminyum Bankolar / Aluminum Desk 	Tasarım Banko Tasarım kule	TAS 604 007 TAS 604 008	Ad Ad	

Ürün Adı ve Görseli / Product Name And The Image	Ölçü / Size HxLxP	Kod no / Code no	Br	Birim Fiyat / Unit Price
Emanet Dolap Ahşap / Wood Safety Cabinet 	Tasarım	TAS 605 002	Kişi	
Emanet Dolap Metal / Metal Safety Cabinet 	Tasarım	TAS 605 003	Kişi	
Soyunma Dolabı 2 Kişilik / Dressing Cabin 	Tasarım	TAS 606 002	Ad	
Soyunma Dolabı 3 Kişilik / Dressing Cabin 	Tasarım	TAS 606 003	Ad	
Soyunma Dolabı 4 Kişilik / Dressing Cabin 	Tasarım	TAS 606 004	Ad	
Soyunma Dolabı 5 Kişilik / Dressing Cabin 	Tasarım	TAS 606 005	Ad	

Ürün Adı ve Görseli / Product Name And The Image	Ölçü / Size HxLxP	Kod no / Code no	Br	Birim Fiyat / Unit Price
<p>Dosya Dolabı</p> 	<p>1950*920*380</p> <p>1800*920*380</p> <p>1100*920*380</p> <p>850*920*380</p>	<p>TAS 607 002</p> <p>TAS 607 003</p> <p>TAS 607 004</p> <p>TAS 607 005</p>		
<p>Dosya Dolabı Sürgülü Stor Kapılı</p> 	<p>1950*1000*450</p> <p>1050*1000*450</p> <p>1050*1200*450</p>	<p>TAS 607 006</p> <p>TAS 607 007</p> <p>TAS 607 008</p>		
<p>Kompakt Dolap</p> 	<p>Sabit</p> <p>Orta</p> <p>Kapaklı</p>	<p>TAS 607 009</p> <p>TAS 607 010</p> <p>TAS 607 011</p>	<p>Tk</p> <p>Tk</p> <p>Tk</p>	
<p>Soyunma Kabinleri / locker Cabinets</p> 	<p>Tasarım</p>	<p>TAS 608 002</p>	<p>Ad</p>	

Ürün Adı ve Görseli / Product Name And The Image	Ölçü / Size HxLxP	Kod no / Code no	Br	Birim Fiyat / Unit Price
Fotoselli Çiftli Yaprak Turnike Electronic Single Door Turnstile 	1070x800	AKS 101 001	Tk	
Tekli Yaprak Turnike Manuel Single Leaf Turnstile Manuel 	1140x650	AKS 102 001	Tk	
Döner Turnike Revolving Turnstile 	1070x1450x650	AKS 103 001	Tk	
Tek Yönlü 2 Soketli Turnike Dikmesi Upright For Turnstile With 2 Sockets One Direction 	H 1070	AKS 104 001	Ad	
Çift Yönlü 4 Soketli Turnike Dikmesi Upright For Turnstile With 2 Sockets Double Direction 	H 1070	AKS 104 002	Ad	
Köşe Yönlü 4 Soketli Turnike Dikmesi Upright For Turnstile With 2 Sockets Corner Direction 	H 1070	AKS 104 003	Ad	
Bariyer Boru Barrier Pipe 	L 1000 L 1500 L 2000	AKS 105 100 AKS 105 150 AKS 105 200	Ad Ad Ad	

Ürün Adı ve Görseli / Product Name And The Image	Ölçü / Size HxLxP	Kod no / Code no	Br	Birim Fiyat / Unit Price
Alüminyum Yer Bariyeri Borusu Ve Fiteli Aluminum in The Barrier Pipe 	L 1000  L 1000 PLS (Fital)	AKS 111 001  AKS 111 002	Mt  Mt	
Alüminyum Yer Bariyeri Bitiş Plastiği Aluminum in The Barrier Plastic Stopper 	Standart	AKS 111 003	AD	
Alüminyum Yer Bariyeri Köşe Dönüş Plastiği Aluminum Barrier Plastic Corner 	Standart	AKS 111 004	Ad	
Alüminyum Yer Bariyeri Ayağı Aluminum Barrier Can Foot 	Standart	AKS 111 005	Ad	



Ürün Adı ve Görseli / Product Name And The Image	Ölçü / Size HxLxP	Kod no / Code no	Br	Birim Fiyat / Unit Price
Plastik El Sepeti Tek Kulplu Eko Plastic Hand Cart Single Handle Eko 	25 LT	AKS 201 001	Ad	
Plastik El Sepeti Çift Kulplu Plastic Hand Basket Double Handled 	25 LT	AKS 201 002	Ad	
Plastik Tekerlekli El Sepeti Eko Plastic Wheel Hand Basket Eko 	43 LT	AKS 202 001	Ad	
Plastik Tekerlekli El Sepeti Plastic Wheel Hand Basket 	43 LT	AKS 202 002	Ad	
Tel El Sepeti Çift Kulplu Wire Basket Double Handle 	25 LT	AKS 203 002	Ad	
Tel Sepeti Stoklama Arabası Wire Basket Collection 		AKS 203 003	Ad	

Ürün Adı ve Görseli / Product Name And The Image	Ölçü / Size HxLxP	Kod no / Code no	Br	Birim Fiyat / Unit Price
Market El Arabası Tel Kasa (Bebe Setli) Wheelbarrow 	075 LT 100 LT 125 LT 150 LT	AKS 211 075 AKS 211 100 AKS 211 125 AKS 211 150	Ad Ad Ad Ad	
Market El Arabası (Çocuk Filamalı) Wheelbarrow Child 	25 LT	AKS 212 025	Ad	
Market El Arabası (Plastik Çocuk Arabalı Tel Kasalı) Wheelbarrow Child 	90 LT	AKS 213 090	AD	



Ürün Adı ve Görseli / Product Name And The Image	Ölçü / Size HxLxP	Kod no / Code no	Br	Birim Fiyat / Unit Price
Kargo Hafif Yük 01 / Light Duty Cargo 01 	1040x970x580	AKS 221 001	Ad	
Kargo Ağır Yük / Heavy Lift Cargo 	890x700x420 1080x650x650	AKS 221 002 AKS 221 003	Ad Ad	
Kargo Ağır Yük / Heavy Lift Cargo 	990x1110x670	AKS 221 004	Ad	
Kargo Ağır Yük / Heavy Lift Cargo 	990x1180x800	AKS 221 005	Ad	
Süper Market Roll 2 Kanatlı / Store Load-Carrying 	1700x810x710	AKS 230 001	Ad	
Süper Market Roll 4 Kanatlı / Store Load-Carrying 	1700x810x710	AKS 230 002	Ad	







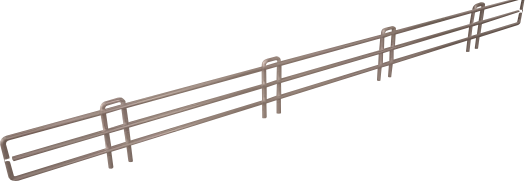

Ürün Adı ve Görseli / Product Name And The Image	Ölçü / Size HxLxP mm	Kod no / Code no	Br	Birim Fiyat / Unit Price
Profil Ayaklı Havuz Sepet / Profile Foot Pool Basket    <i>B = BOYALI</i> <i>C = CİNKO</i> <i>N = NİKEL</i>	850x600x800	AKS 301 6080 B	Ad	
	850x800x800	AKS 301 8080 B	Ad	
	850x800x1200	AKS 301 80120 B	Ad	
	850x600x800	AKS 301 6080 C	Ad	
	850x800x800	AKS 301 8080 C	Ad	
	850x800x1200	AKS 301 80120 C	Ad	
	850x600x800	AKS 301 6080 N	Ad	
	850x800x800	AKS 301 8080 N	Ad	
	850x800x1200	AKS 301 80120 N	Ad	
Profil Ayaklı Havuz Sepet / Profile Foot Pool Basket    <i>B = BOYALI</i> <i>C = CİNKO</i> <i>N = NİKEL</i>	850x600x800	AKS 302 6080 B	Ad	
	850x800x800	AKS 302 8080 B	Ad	
	850x800x1200	AKS 302 80120 B	Ad	
	850x600x800	AKS 302 6080 C	Ad	
	850x800x800	AKS 302 8080 C	Ad	
	850x800x1200	AKS 302 80120 C	Ad	
	850x600x800	AKS 302 6080 N	Ad	
	850x800x800	AKS 302 8080 N	Ad	
	850x800x1200	AKS 302 80120 N	Ad	

Ürün Adı ve Görseli / Product Name And The Image	Ölçü / Size HxLxP mm	Kod no / Code no	Br	Birim Fiyat / Unit Price
Tekerlekli Havuz Sepet Wheel Profile Legged Baskets  <i>B = BOYALI</i> <i>C = CİNKO</i> <i>N = NİKEL</i>	850x800x1200	AKS 303 80120 B	Ad	
	850x800x1200	AKS 303 80120 C	Ad	
	850x800x1200	AKS 303 80120 N	Ad	
Tekerlekli Havuz Sepet Wheel Profile Legged Baskets  <i>B = BOYALI</i> <i>C = CİNKO</i> <i>N = NİKEL</i>	850x800x1200	AKS 304 80120 B	Ad	
	850x800x1200	AKS 304 80120 C	Ad	
	850x800x1200	AKS 304 80120 N	Ad	
Tel Ayaklı Havuz Sepet / Wire Baskets  <i>B = BOYALI</i> <i>C = CİNKO</i> <i>N = NİKEL</i>	700x530x530	AKS 305 5353 B	Ad	
	800x630x630	AKS 305 6363 B	Ad	
	800x800x800	AKS 305 8080 B	Ad	
	700x530x530	AKS 305 5353 C	Ad	
	800x630x630	AKS 305 6363 C	Ad	
	800x800x800	AKS 305 8080 C	Ad	
	700x530x530	AKS 305 5353 N	Ad	
	800x630x630	AKS 305 6363 N	Ad	
	800x800x800	AKS 305 8080 N	Ad	





Ürün Adı ve Görseli / Product Name And The Image	Ölçü / Size HxLxP mm	Kod no / Code no	Br	Birim Fiyat / Unit Price
Boru Ayaklı Havuz Sepet / Pipe Leg Baskets  <p><i>BN = BOYALI VE NİKEL</i></p>	900x600x800 900x800x1200	AKS 306 6080 BN AKS 306 80120 BN	Ad Ad	
Konteyner / Container Basket  <p><i>C = CİNKO</i></p>	640x600x800 840x800x1000 900x1000x1200	AKS 307 6080 C AKS 307 80100 C AKS 307 100120 C	Ad Ad Ad	
Konteyner / Container Basket  <p><i>C = CİNKO</i></p>	900x800x1200	AKS 308 80120 C	Ad	
Klasik Havuz Sepet / Classic Baskets  <p><i>B = BOYALI</i></p>	800x600x800 800x600x1100	AKS 309 6080 B AKS 309 60110 B	Ad Ad	

Ürün Adı ve Görseli / Product Name And The Image	Ölçü / Size HxLxP mm	Kod no / Code no	Br	Birim Fiyat / Unit Price
Aksiyon Standı Üç Katlı / Action Stand  <b>C = CİNKO</b> <b>ÖLÇÜLER DEĞİŞE BİLİR</b>	1610x640x800 1628x840x1200	AKS 310 6480 C AKS 310 84120 C	Ad Ad	
Aksiyon Standı Dört katlı / Action Stand  <b>C = CİNKO</b> <b>ÖLÇÜLER DEĞİŞE BİLİR</b>	1610x640x800 1628x840x1200	AKS 311 6480 C AKS 311 84120 C	Ad Ad	

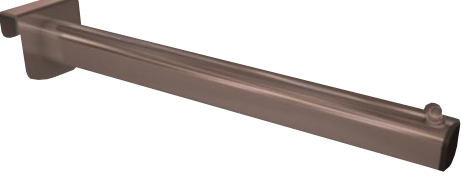
Ürün Adı ve Görseli / Product Name And The Image	Ölçü / Size HxLxP	Kod no / Code no	Br	Birim Fiyat / Unit Price
Ünite Önü Bariyer Boru 	L 600	AKS 401 060	Ad	
	L 700	AKS 401 070	Ad	
	L 800	AKS 401 080	Ad	
	L 900	AKS 401 090	Ad	
	L 1000	AKS 401 100	Ad	
	L 1150	AKS 401 115	Ad	
	L 1250	AKS 401 125	Ad	
	L 1330	AKS 401 133	Ad	
Raf Önü Siperlik Teli / Front Wire Shelf 	L 600 mm	AKS 411 060	Ad	
	L 700 mm	AKS 411 070	Ad	
	L 800 mm	AKS 411 080	Ad	
	L 900 mm	AKS 411 090	Ad	
	L 1000 mm	AKS 411 100	Ad	
	L 1150 mm	AKS 411 115	Ad	
	L 1250 mm	AKS 411 125	Ad	
	L 1330 mm	AKS 411 133	Ad	
Köşeli U Boru Askı / The square U-Pipe Hanger 	L 600 mm	AKS 421 060	Ad	
	L 700 mm	AKS 421 070	Ad	
	L 800 mm	AKS 421 080	Ad	
	L 900 mm	AKS 421 090	Ad	
	L 1000 mm	AKS 421 100	Ad	
	L 1150 mm	AKS 421 115	Ad	
	L 1250 mm	AKS 421 125	Ad	
	L 1330 mm	AKS 421 133	Ad	
Eleman Tutucu 20X30 / Element Holder 20x30 	L 600 mm	AKS 431 060	Ad	
	L 700 mm	AKS 431 070	Ad	
	L 800 mm	AKS 431 080	Ad	
	L 900 mm	AKS 431 090	Ad	
	L 1000 mm	AKS 431 100	Ad	
	L 1150 mm	AKS 431 115	Ad	
	L 1250 mm	AKS 431 125	Ad	
	L 1330 mm	AKS 431 133	Ad	

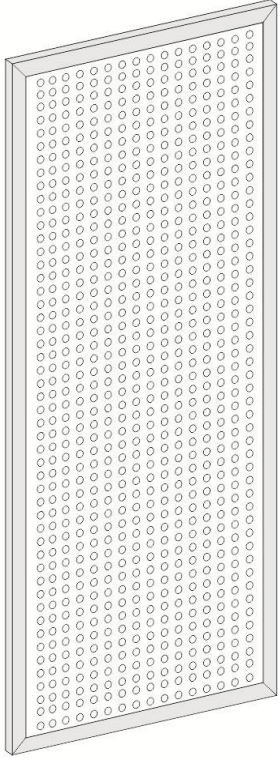

Ürün Adı ve Görseli / Product Name And The Image	Ölçü / Size HxLxP	Kod no / Code no	Br	Birim Fiyat / Unit Price
Tutucuya Geçen Kanca Teli Tekli Single Wire Hook 	P 100 mm	AKS 441 010	Ad	
	P 150 mm	AKS 441 015	Ad	
	P 200 mm	AKS 441 020	Ad	
	P 250 mm	AKS 441 025	Ad	
	P 300 mm	AKS 441 030	Ad	
	P 350 mm	AKS 441 035	Ad	
Tutucuya Geçen Kanca Teli Tekli Etiketli Label Hook wire 	P 200 mm	AKS 442 020	Ad	
	P 250 mm	AKS 442 025	Ad	
	P 300 mm	AKS 442 030	Ad	
	P 350 mm	AKS 442 035	Ad	
Tutucuya Geçen Kanca Teli Çiftli Double Hook Wire 	P 200 mm	AKS 443 020	Ad	
	P 250 mm	AKS 443 025	Ad	
	P 300 mm	AKS 443 030	Ad	
	P 350 mm	AKS 443 035	Ad	

Ürün Adı ve Görseli / Product Name And The Image	Ölçü / Size HxLxP	Kod no / Code no	Br	Birim Fiyat / Unit Price
Tutucuya Geçen Düz Spot / Flat Spot  	P 300 mm	AKS 444 030	Ad	
	P 350 mm	AKS 444 035	Ad	
	P 400 mm	AKS 444 040	Ad	
Tutucuya Geçen Eğimli Spot / Spot Curve  	P 300 mm	AKS 445 030	Ad	
	P 350 mm	AKS 445 035	Ad	
	P 400 mm	AKS 445 040	Ad	
Tutucuya Geçen Yay Spot / Spot Wire  	P 300 mm	AKS 446 030	Ad	
	P 350 mm	AKS 446 035	Ad	
	P 400 mm	AKS 446 040	Ad	

Ürün Adı ve Görseli / Product Name And The Image	Ölçü / Size HxLxP	Kod no / Code no	Br	Birim Fiyat / Unit Price
Delikli Pano Klasik Delikli / Perforated Panel classical 	Standart	AKS 500 001	M2	
Delikli Panoya Geçen Kanca Teli Tekli Single Wire Hook 	P 100 mm P 150 mm P 200 mm P 250 mm P 300 mm P 350 mm	AKS 511 010 AKS 511 015 AKS 511 020 AKS 511 025 AKS 511 030 AKS 511 035	Ad Ad Ad Ad Ad Ad	
Delikli Panoya Geçen Kanca Teli Tekli Etiketli Label Hook Wire 	P 200 mm P 250 mm P 300 mm P 350 mm	AKS 512 020 AKS 512 025 AKS 512 030 AKS 512 035	Ad Ad Ad Ad	
Delikli Panoya Geçen Kanca Teli Çiftli Double Hook Wire 	P 200 mm P 250 mm P 300 mm P 350 mm	AKS 513 020 AKS 513 025 AKS 513 030 AKS 513 035	Ad Ad Ad Ad	

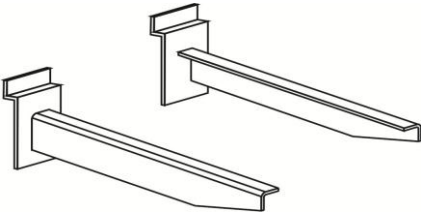
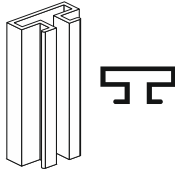
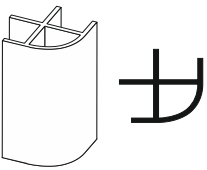
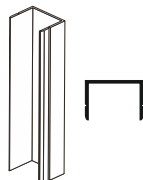





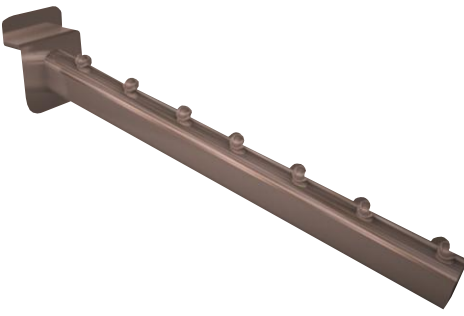

Ürün Adı ve Görseli / Product Name And The Image	Ölçü / Size HxLxP	Kod no / Code no	Br	Birim Fiyat / Unit Price
Kanal Pano / Slat Panel 	100 mm ara ile 150 mm ara ile 200 mm ara ile 250 mm ara ile	AKS 601 010 AKS 601 015 AKS 601 020 AKS 601 025	M2 M2 M2 M2	
Kanal Pano Konsolu / Slat Panel Console 	P 150 P 200 P 250	AKS 611 015 AKS 611 020 AKS 611 025	Ad Ad Ad	
Kanal Pano Alüminyum / Slat Panel Aluminum 	St.	35 ALM 1044 A	Mt	
Köşe Alüminyum 18 mm / Aluminum Corner 18 mm 	St.	35 ALM 1052 F	Mt	
Geniş Çizgili U Alüminyum / Wide Striped U Aluminum 	St.	35 ALM 1055 H	Mt	





Ürün Adı ve Görseli / Product Name And The Image	Ölçü / Size HxLxP	Kod no / Code no	Br	Birim Fiyat / Unit Price
Kanal Panoya Geçen Kanca Teli Tekli Single Wire Hook 	P 100 mm	AKS 621 010	Ad	
	P 150 mm	AKS 621 015	Ad	
	P 200 mm	AKS 621 020	Ad	
	P 250 mm	AKS 621 025	Ad	
	P 300 mm	AKS 621 030	Ad	
	P 350 mm	AKS 621 035	Ad	
Kanal Panoya Geçen Kanca Teli Tekli Etiketli Label Hook Wire 	P 200 mm	AKS 622 020	Ad	
	P 250 mm	AKS 622 025	Ad	
	P 300 mm	AKS 622 030	Ad	
	P 350 mm	AKS 622 035	Ad	
Kanal Panoya Geçen Kanca Teli Çiftli Double Hook Wire 	P 200 mm	AKS 623 020	Ad	
	P 250 mm	AKS 623 025	Ad	
	P 300 mm	AKS 623 030	Ad	
	P 350 mm	AKS 623 035	Ad	





Ürün Adı ve Görseli / Product Name And The Image	Ölçü / Size HxLxP	Kod no / Code no	Br	Birim Fiyat / Unit Price
Kanal Panoya Geçen Düz Spot / Flat Spot 	P 300 mm	AKS 624 030	Ad	
	P 350 mm	AKS 624 035	Ad	
	P 400 mm	AKS 624 040	Ad	
Kanal Panoya Geçen Eğimli Spot / Spot Curve 	P 300 mm	AKS 625 030	Ad	
	P 350 mm	AKS 625 035	Ad	
	P 400 mm	AKS 625 040	Ad	
Kanal Panoya Geçen Yay Spot / Spot Wire 	P 300 mm	AKS 626 030	Ad	
	P 350 mm	AKS 626 035	Ad	
	P 400 mm	AKS 626 040	Ad	

Ürün Adı ve Görseli / Product Name And The Image	Ölçü / Size HxLxP	Kod no / Code no	Br	Birim Fiyat / Unit Price
Bayan Tors Ten / Model Tors 	Standart	AKS 701 2601	Ad	
Erkek Tors Ten / Model Tors 	Standart	AKS 701 2502	Ad	
Zeyna Ten / Model Zeyna 	Standart	AKS 701 2604	Ad	
Herkül Ten / Model Herkül 	Standart	AKS 701 2605	Ad	
Çamarlık Ten / Lingerie Model 	Standart	AKS 701 2606	Ad	
Uzun Kafa Ten / Model, The Long Head 	Standart	AKS 701 2607	Ad	

Ürün Adı ve Görseli / Product Name And The Image	Ölçü / Size HxLxP	Kod no / Code no	Br	Birim Fiyat / Unit Price
Kısa Kafa Bayan Erkek Ten / Model, The Short Head 	Standart	AKS 701 2608	Ad	
Uzun Soket Çorap Ten / Model Long Socket Sock 	Standart	AKS 701 2609	Ad	
Bayan Çoraplık + Telli Ten / Socks Wire Model 	Standart	AKS 701 2712	Tk	
Bayan ve Erkek Bacak Ten / Model Leg 	Bayan	AKS 701 2713	Ad	
Bayan ve Erkek Terzi Ahşap Tailor's Mannequin Model 	Bayan	AKS 701 2407	Ad	
Beşli Set Takım / Five Model 	Boyalı	AKS 701 1306	Tk	
Bayan ve Erkek Manken + Demir / All Mannequin 	Bayan Erkek	AKS 701 2001 AKS 701 2201	Ad Ad	

Ürün Adı ve Görseli / Product Name And The Image	Ölçü / Size HxLxP	Kod no / Code no	Br	Birim Fiyat / Unit Price
Klasik Daire / Classic Apartment 	Boyalı	AKS 701 1301	Ad	
Klasik Helezon / Classic Helezon 	Boyalı	AKS 701 1302	Ad	
Klasik Ufi / Classic Ufi 	Boyalı	AKS 701 1303	Ad	
Klasik Çift Katlı / Classic Double Layer 	Boyalı	AKS 701 1204	Ad	
Klasik Tek Katlı / Classic Single Story 	Boyalı	AKS 701 1205	Ad	
Klasik Tek Katlı Sabit / Classic Single Layer Fixed 	Boyalı	AKS 701 1206	Ad	

Ürün Adı ve Görseli / Product Name And The Image	Ölçü / Size HxLxP	Kod no / Code no	Br	Birim Fiyat / Unit Price
Klasik V Ayarlı / Classic V Adjustable 	Boyalı	AKS 701 1207	Ad	
Tel Pano / Wire Panel 	Boyalı	AKS 701 1101	Tk	
Lüks Helezon / Luxury Helezon 	Crom	AKS 701 901	Ad	
Lüks Ufi / Luxury Ufi 	Crom	AKS 701 902	Ad	
Lüks Daire / luxury Apartment 	Crom	AKS 701 903	Ad	

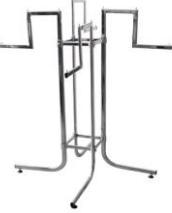
Ürün Adı ve Görseli / Product Name And The Image	Ölçü / Size HxLxP	Kod no / Code no	Br	Birim Fiyat / Unit Price
Lüks Çift Katlı / Luxury Double Storey 	Crom	AKS 701 1201	Ad	
Lüks Tek Katlı /Luxury Single Story 	Crom	AKS 701 1202	Ad	
Lüks Köşe Kemerlik / Luxury Corner Belt 	Crom	AKS 701 1305	Ad	
Lüks Kemerlik / luxury Belt 	Crom	AKS 701 1003	Ad	
Tel Pano / Wire Panel 	Crom	AKS 701 1102	Tk	
Akrobat / Acrobat 	Crom	AKS 701 001	Ad	





